

CREATE
YOUR STYLE
with SWAROVSKI ELEMENTS

DESIGN PROJECT
SUMMER HOLIDAY
LUGGAGE TAG
FISH



LUGGAGE TAG "FISH"



SWAROVSKI ELEMENTS

Supplies & Tools

Article	Product Group	Article No.	Amount	Size	Colour	Colour Code
	Sew-on Stones	3200	2 pcs.	10mm	Light Topaz F	226
	Sew-on Stones	3204	1 pc.	8mm	Amethyst F	204
	Sew-on Stones	3204	2 pcs.	8mm	Indicolite F	379
	Sew-on Stones	3204	1 pc.	10mm	Indicolite F	379
	Sew-on Stones	3210	2 pcs.	10x7mm	Light Sapphire F	211
	Sew-on Stones	3230	3 pcs.	12x7mm	Olivine F	228
	Sew-on Stones	3250	1 pc.	18x13mm	Crystal Tabac F	001 TAB
	Sew-on Stones	3255	1 pc.	18x6mm	Crystal Red Magma F	001 REDM
	Sew-on Stones	3265	1 pc.	20x16mm	Crystal Red Magma F	001 REDM
	Sew-on Stones	3270	2 pcs.	16mm	Crystal Volcano F	001 VOL

- Supplies**
- 1x Clasp, gold
 - Leather/Alcantara, dark red, 20x40cm
 - 2m Nylon thread, transparent, Ø 0.15mm
 - 1x Platic folder, transparent, DIN A4
 - Sewing silk, dark red
 - Interlining, 15x5cm
- Tools**
- Double sided sticky tape
 - Iron
 - Needle
 - Punching pliers
 - Scissors
 - Sewing machine
 - 1x Sheet of paper, light rose, DIN A4

Level of design: INTERMEDIATE

Have also a look at the **text instruction** at the last page!

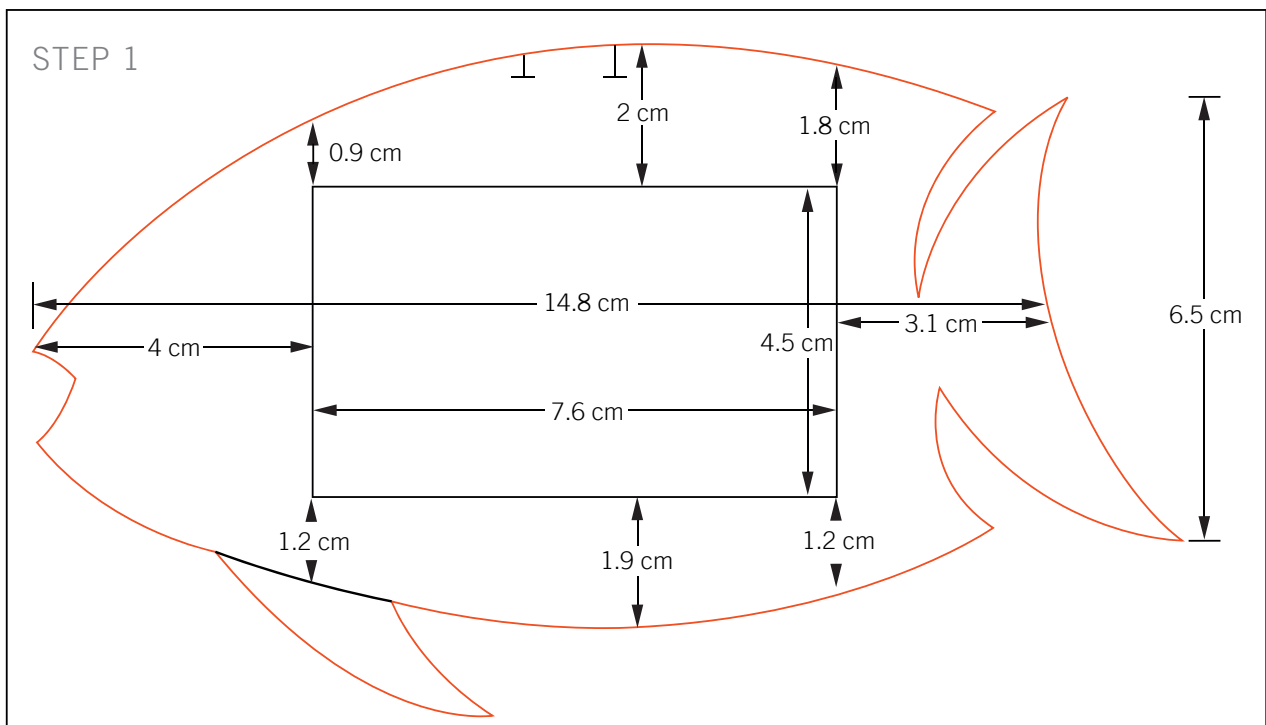

STEP 2

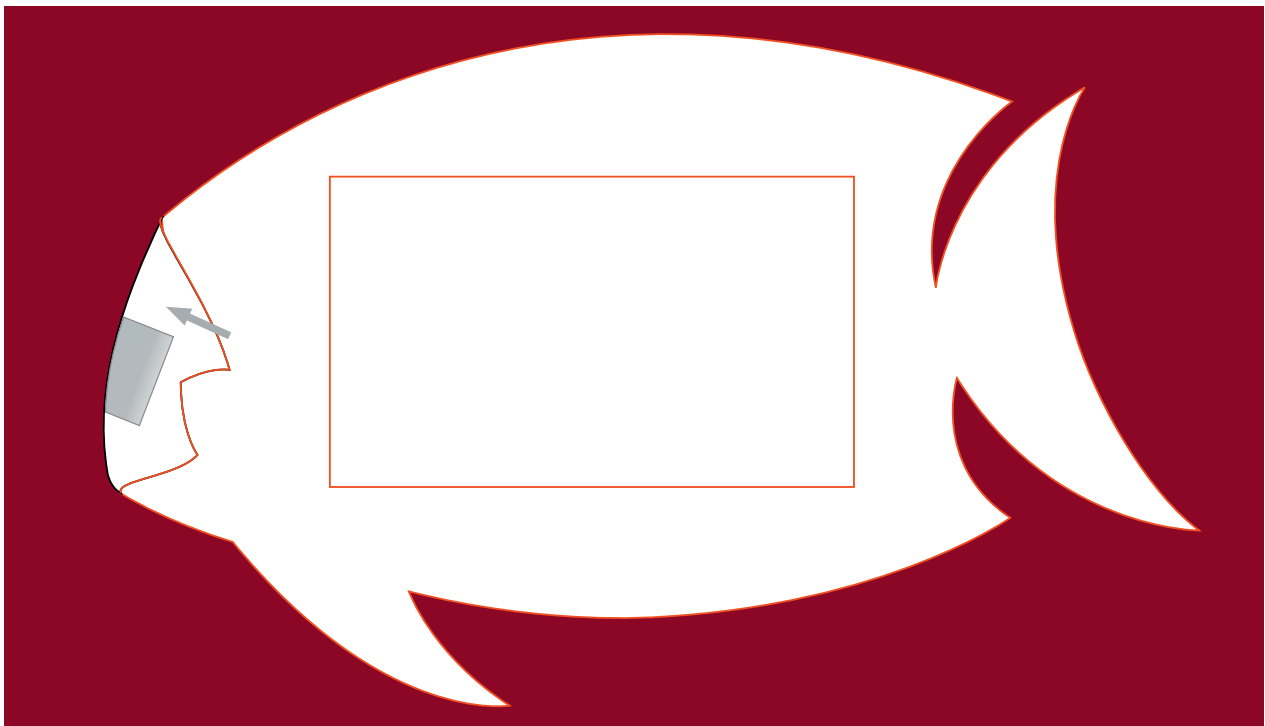
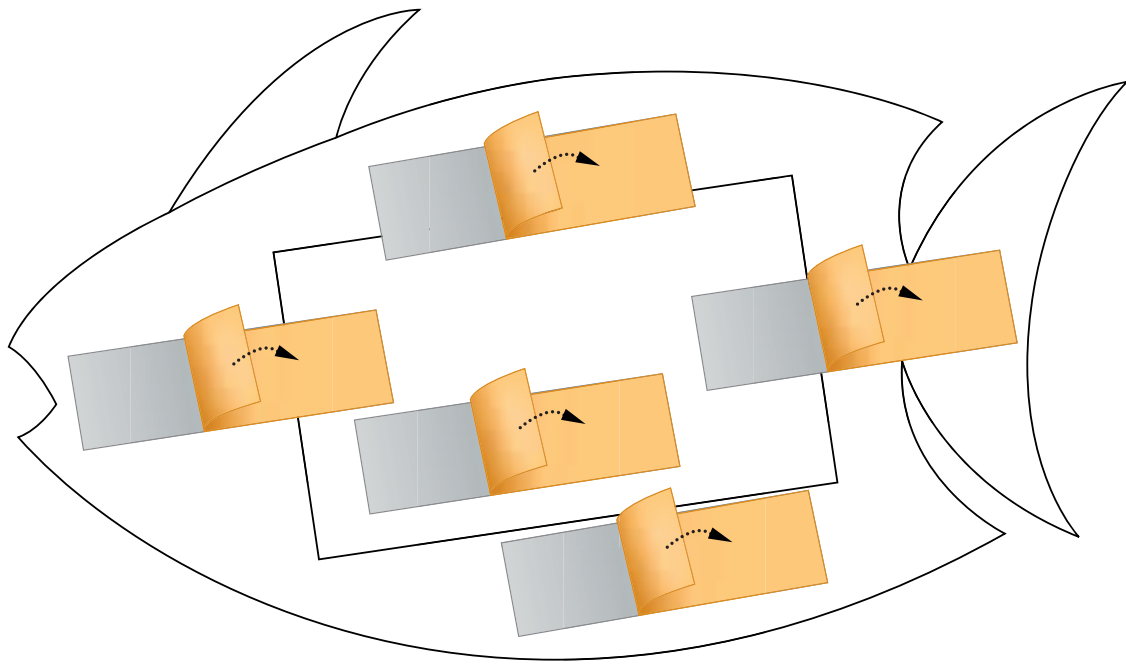

STEP 3

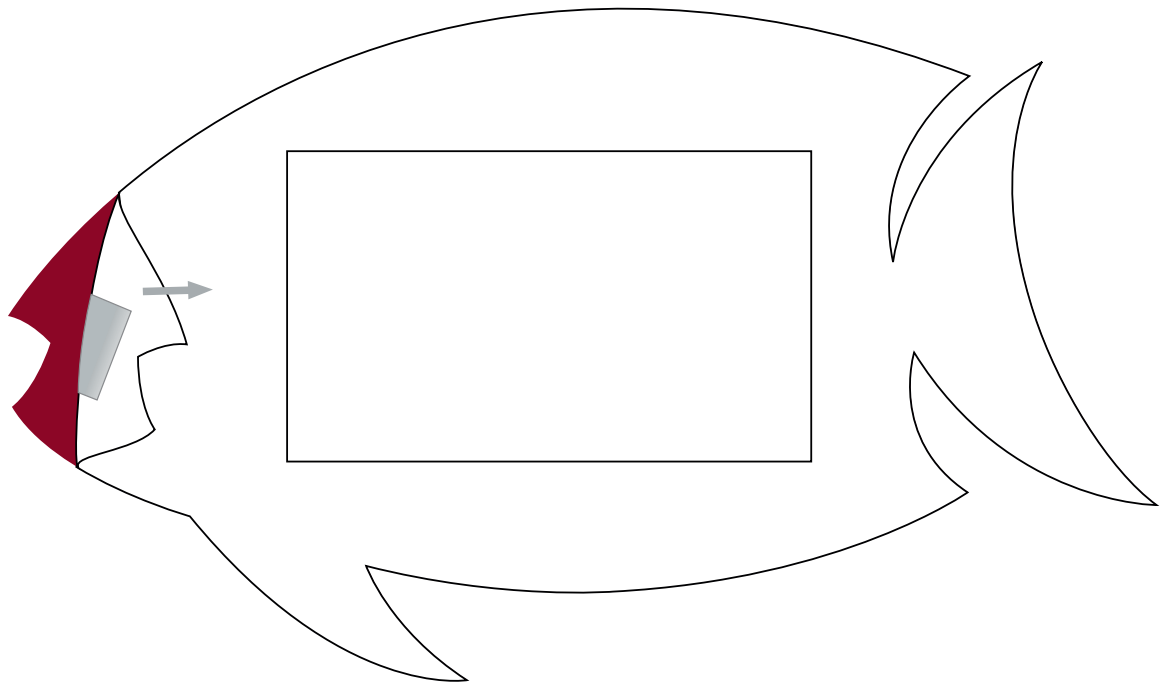

STEP 4

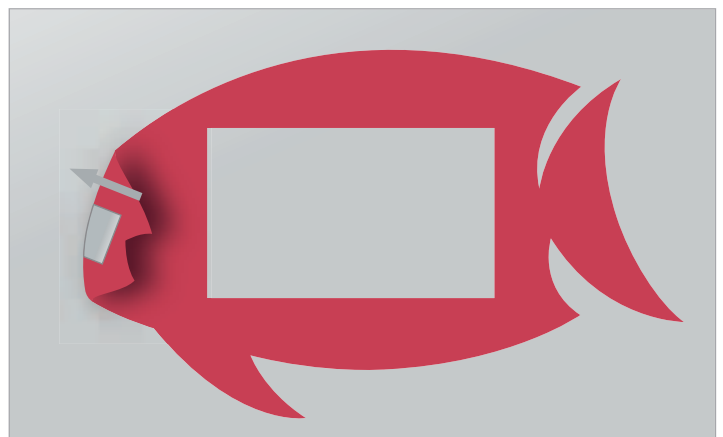
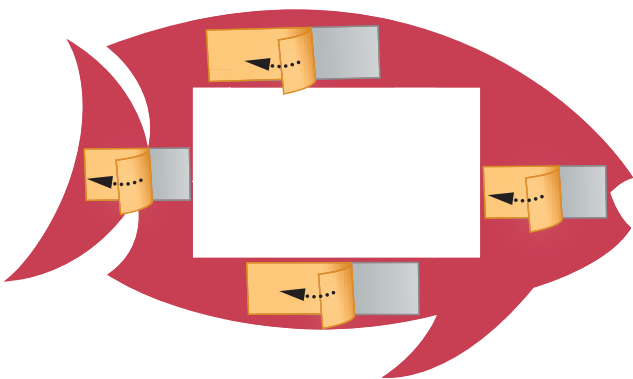

1:2

STEP 5

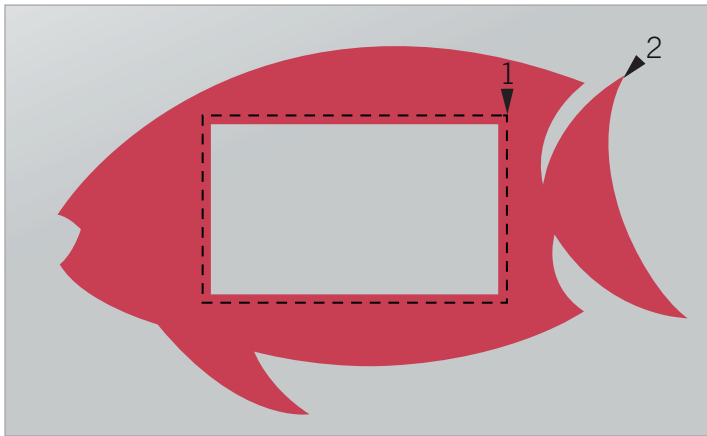

1



2

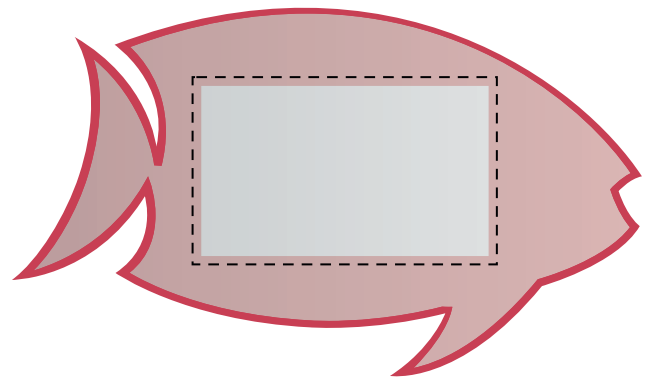
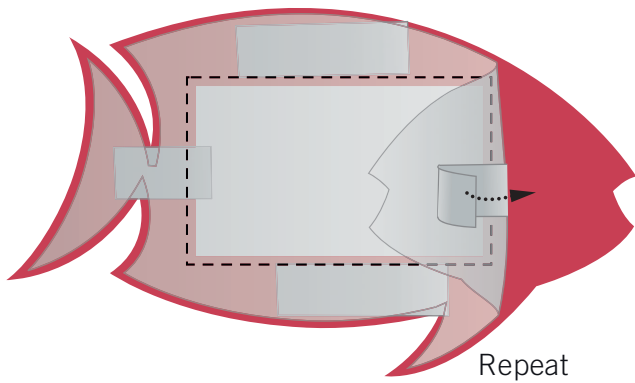

STEP 6

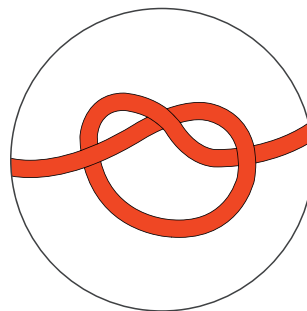
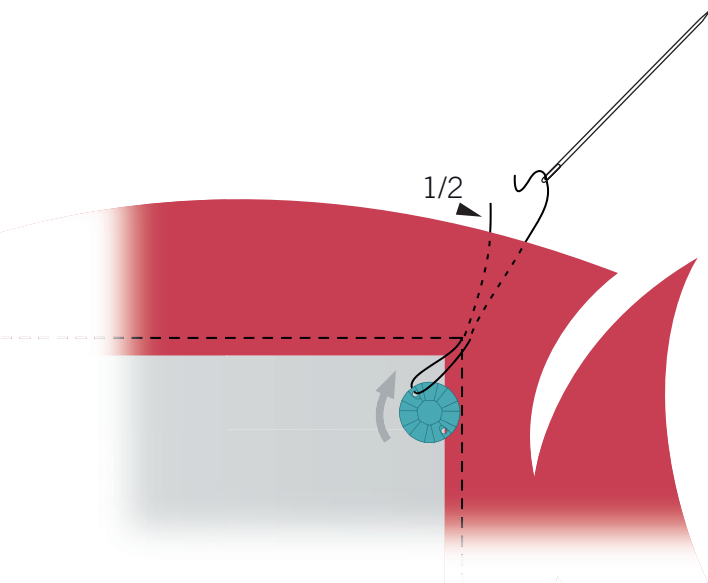

1



2

1:1

STEP 7

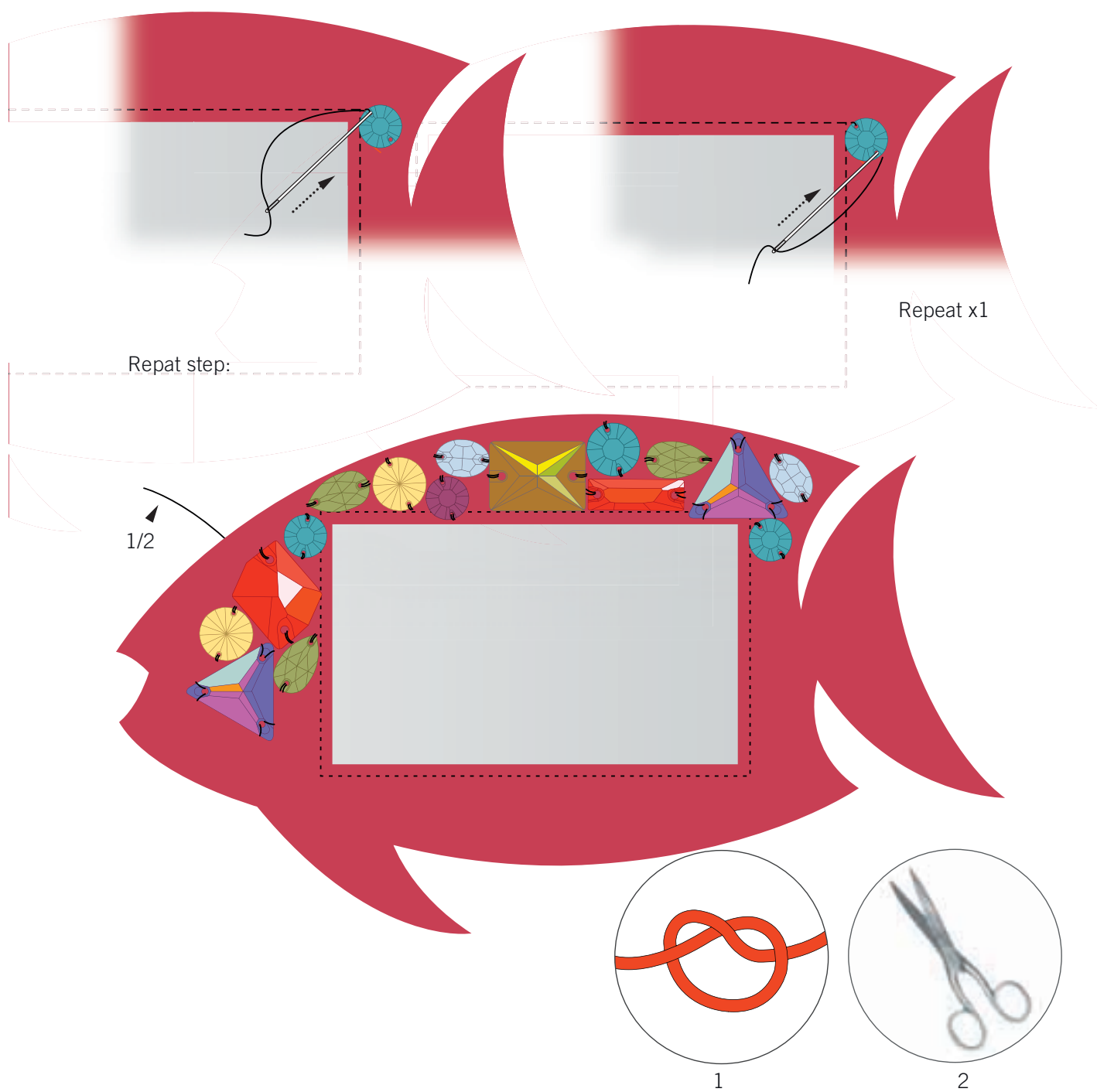

STEP 8

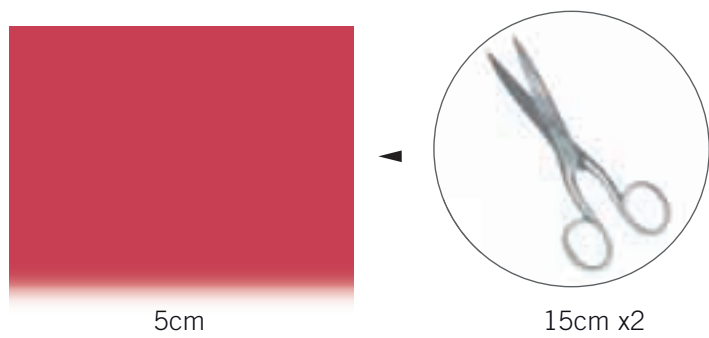

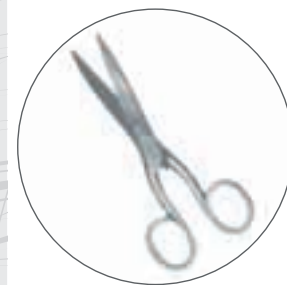
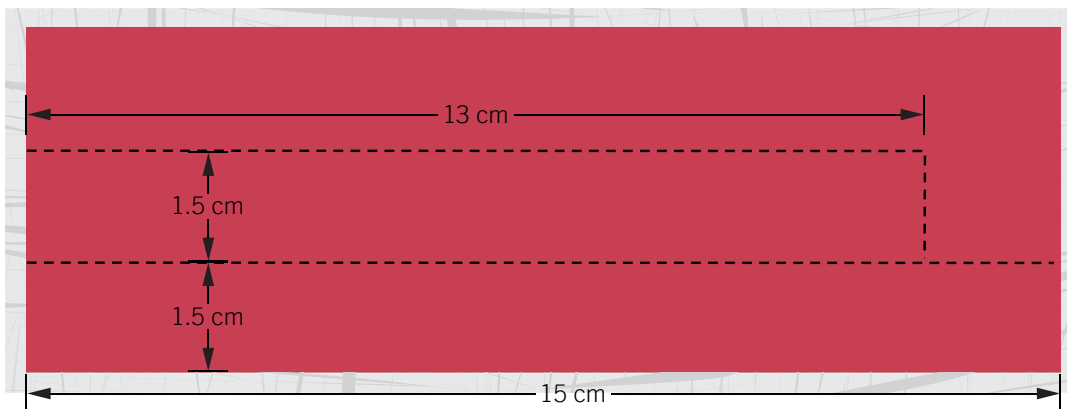

STEP 9

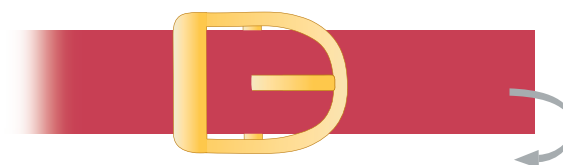
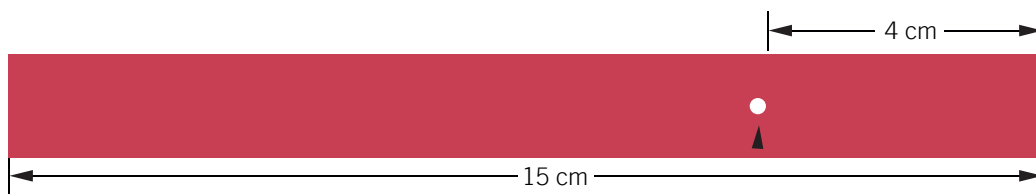

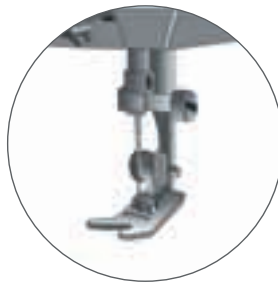
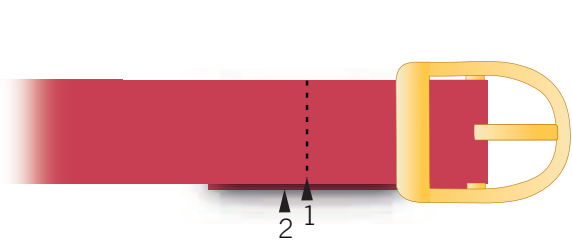

1



2

STEP 10

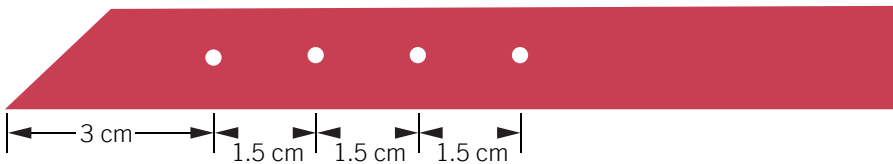

STEP 11

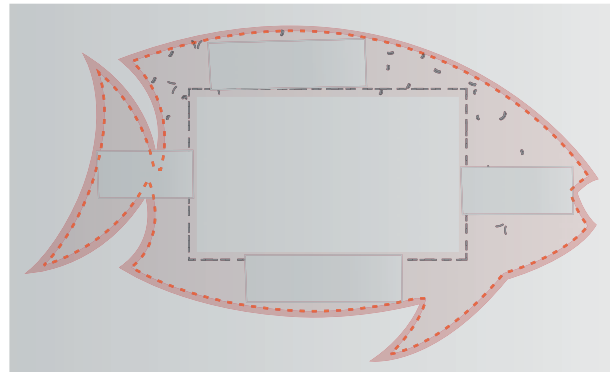
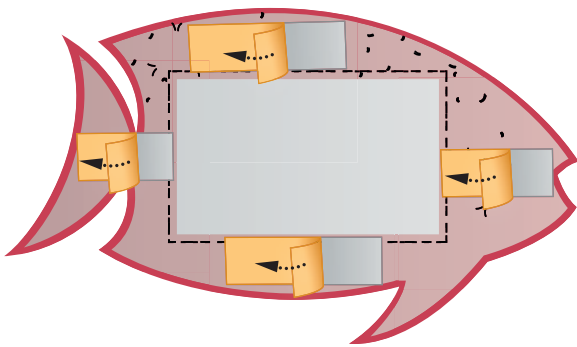

1:2

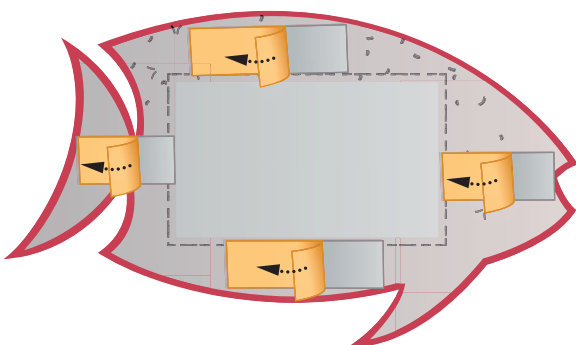

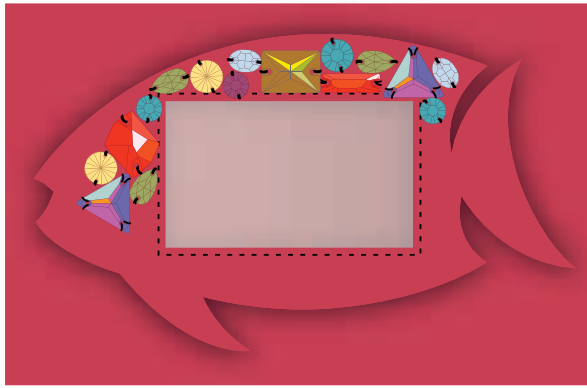

STEP 12



STEP 13

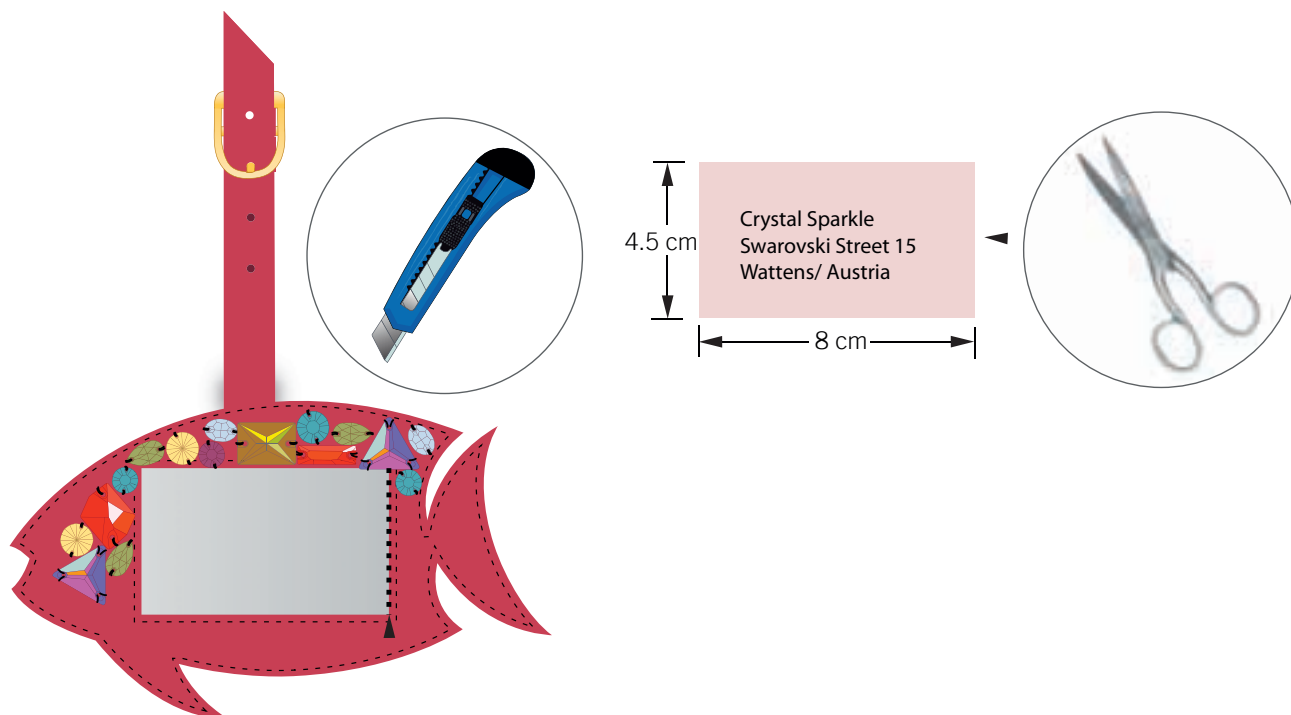



CREATE YOUR STYLE Design Project

Summer Holiday Luggage Tag "Fish"

- STEP 1: Print out pattern with measurements as you see in illustration and cut out fish along red outline with scissors.
- STEP 2: Put some double sided tape behind the pattern, affix it to the leather and cut out outline of pattern and rectangle which are marked with red lines in illustration.
- STEP 3: Remove paper pattern from leather fish.
- STEP 4: Put some double sided tape onto back side of leather fish and glue it onto a plastic folder.
- STEP 5: Sew with sewing machine along outline of rectangle as arrow head with number 1 depicts in illustration, then cut plastic folder a few millimeters inside the leather fish as arrow head number 2 shows. Remove all double sided sticky tape pieces from plastic and leather.
- STEP 6: Thread a needle with nylon thread and tie a simple knot. Attach the first Sew-on Stone from the SWAROVSKI ELEMENTS assortment. Each Swarovski Sew-on Stone should be affixed with 2 stitches per hole.
- STEP 7: Repeat this step with remaining SWAROVSKI ELEMENTS. See illustration for placement of crystals. After sewing last Swarovski Sew-on Stone onto leather make a knot and cut off excess nylon thread.
- STEP 8: Cut 2 15x15cm stripes of leather. Put the interlining in between and iron the pieces together. Cut out of ironed piece one 13x1.5cm stripe and one 15x1.5cm stripe.
- STEP 9: Punch into the 15cm long stripe a hole with punching pliers, slide the buckle onto the stripe and go through the hole as you see in illustration. Fold the leather in front of the hole to the back side and sew in place.
- STEP 10: Cut an angle on one side of 13cm long leather stripe as shown in the illustration and punch 4 holes with punching pliers.
- STEP 11: Put some double sided tape onto back side of fish (where plastic is sewn on) and put the plastic on top of fish (please take care that there is no tape inside of inner rectangle). Cut out the plastic along outline of fish as you see in illustration. Put some more double sided sticky tape onto plastic and stick fish onto a leather piece.
- STEP 12: Put both ends of the stripes with clasp between fish and leather piece and sew all around outline of fish. For sewing use zipper foot as you see in illustration, so that the SWAROVSKI ELEMENTS don't get destroyed. Then cut out fish along out line as you see in illustration.
- STEP 13: Cut one side of the plastic with cutter along fat dotted line (as arrow head depicts in illustration- don't cut through fish, just cut the upper plastic). Print out your name and address onto rose paper and cut paper to a rectangle of 4.5x8cm. Insert into plastic part of the fish.