

CREATE
YOUR STYLE
with SWAROVSKI ELEMENTS



DESIGN PROJECT
SUMMER HOLIDAYS
NECKLACE
"SAND DUNE"

SUMMER HOLIDAYS NECKLACE "SAND DUNE"



SWAROVSKI ELEMENTS

Article	Product Group	Article No.	Amount	Size	Color	Color Code
	Fancy Stones	4137	2 pcs.	22x16 mm	Crystal Red Magma	001 REDM
	Fancy Stones	4137	1 pc.	22x16 mm	Crystal Tabac	001 TAB
	Fancy Stones	4139	3 pcs.	14 mm	Crystal Copper	001 COP
	Fancy Stones	4139	1 pc.	14 mm	Crystal Golden Shadow	001 GSHA
	Fancy Stones	4139	2 pcs.	14 mm	Crystal Red Magma	001 REDM
	Fancy Stones	4139	2 pcs.	14 mm	Crystal Sahara	001 SAH
	Fancy Stones	4139	1 pc.	14 mm	Crystal Tabac	001 TAB
	Fancy Stones	4439	2 pcs.	20 mm	Crystal Red Magma	001 REDM
	Fancy Stones	4439	1 pc.	20 mm	Crystal Sahara	001 SAH
	Beads	5000	52 pcs.	8 mm	Garnet	241
	Crystal Pearls	5810	47 pcs.	8 mm	Crystal Antique Brass Pearl	001 402

Supplies & Tools

- Supplies**
- Button silk, any color, 1 m
 - Chain, bronze, 92 cm
 - Crimping tubes, bronze
 - Fabric, auburn, 50x40 cm
 - Fabric, brown, 50x40 cm
 - Fabric, red, 50x40 cm
 - Fabric, sand, 50x40 cm
 - Hemb ribbon, nature, Ø7 mm, 1.5 m
 - 2x Jump ring, bronze, Ø8 mm
 - 101x Jump ring, bronze, Ø12 mm
 - 1x Lobster clasp, bronze
 - Sewing silk, auburn
 - Sewing silk, brown
 - Sewing silk, red
 - Sewing silk, sand
 - 2x Split ring, bronze, Ø9 mm
 - Tiger tail, bronze, Ø0.3 mm, 2.4 m

- Tools**
- Crimping pliers
 - Flat nose pliers
 - Scissors
 - Sewing machine
 - Sewing needle
 - Side cutter
 - Tape

Level of design: INTERMEDIATE

Have also a look at the **text instruction** at the last page!

STEP 1

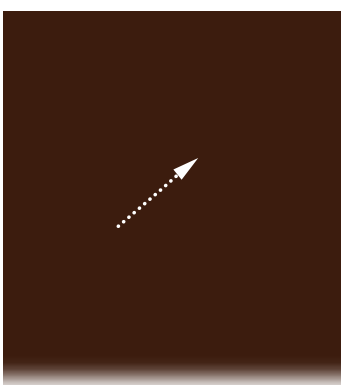

A

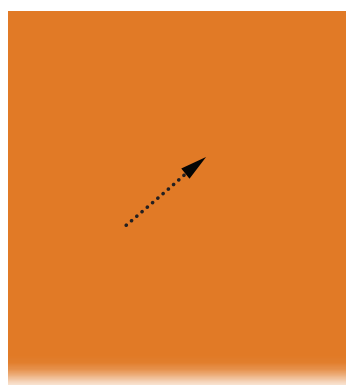

B

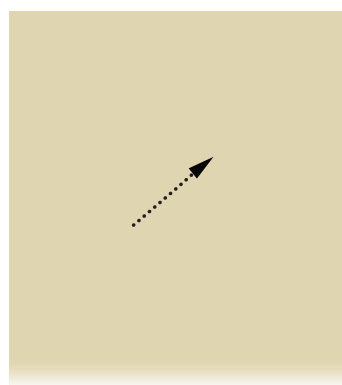

C



- A = 47x4.5 cm
- B = 26x4.5 cm
- C = 32x4.5 cm
- D = 40x4.5 cm

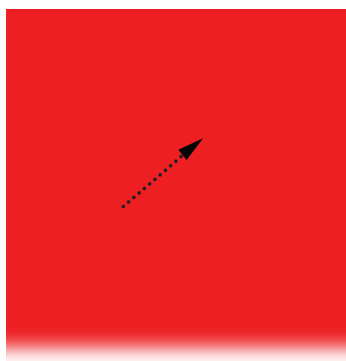

D

STEP 2

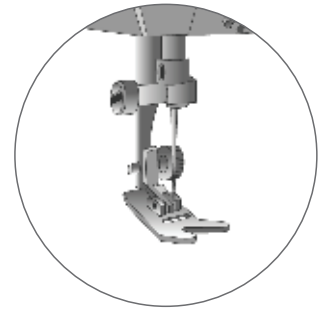
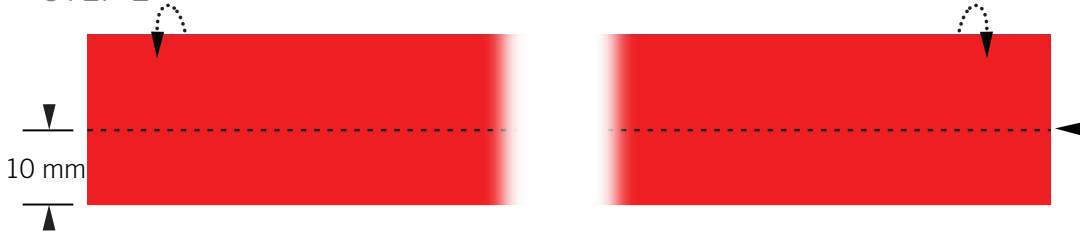

Repeat step x3

STEP 3

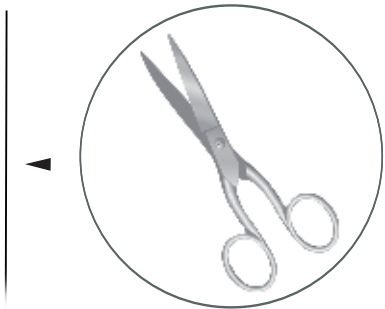

50 cm

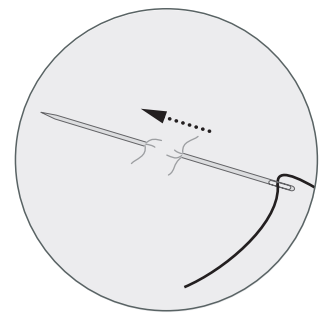
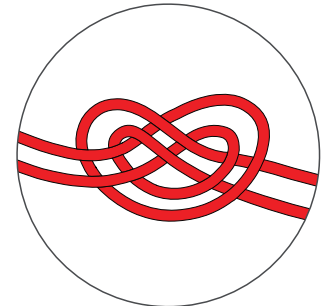

x2

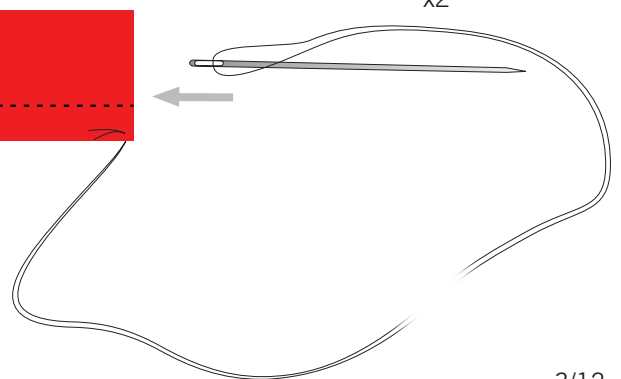

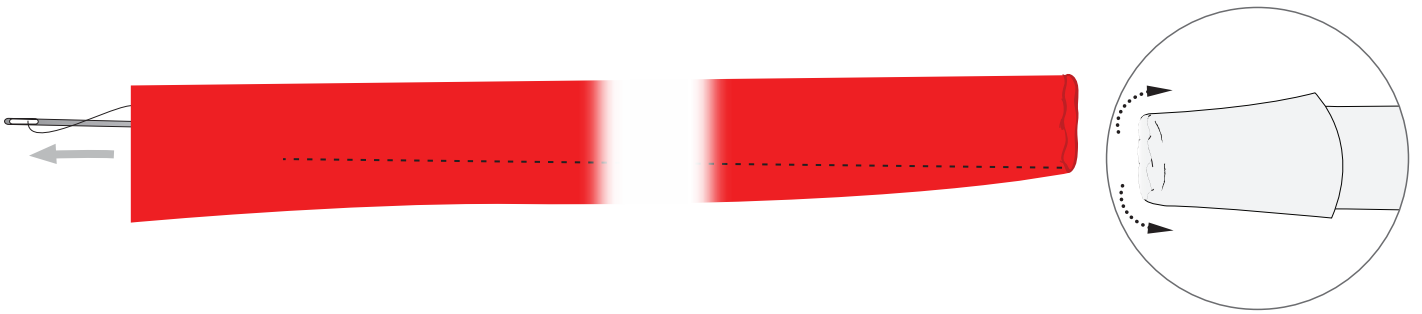

Repeat step 3 x3:



STEP 4

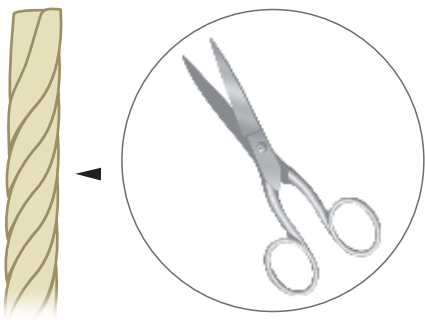

- A = 44 cm
- B = 23 cm
- C = 29 cm
- D = 37 cm

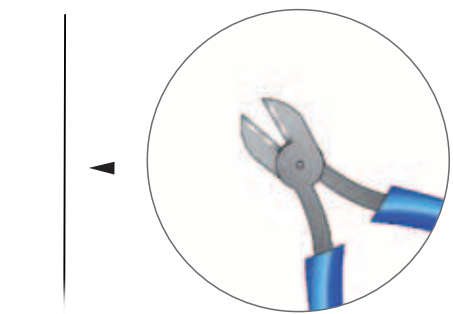

0.3 mm

60 cm

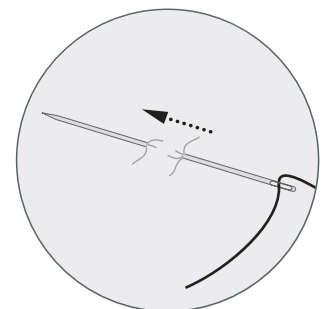

x4

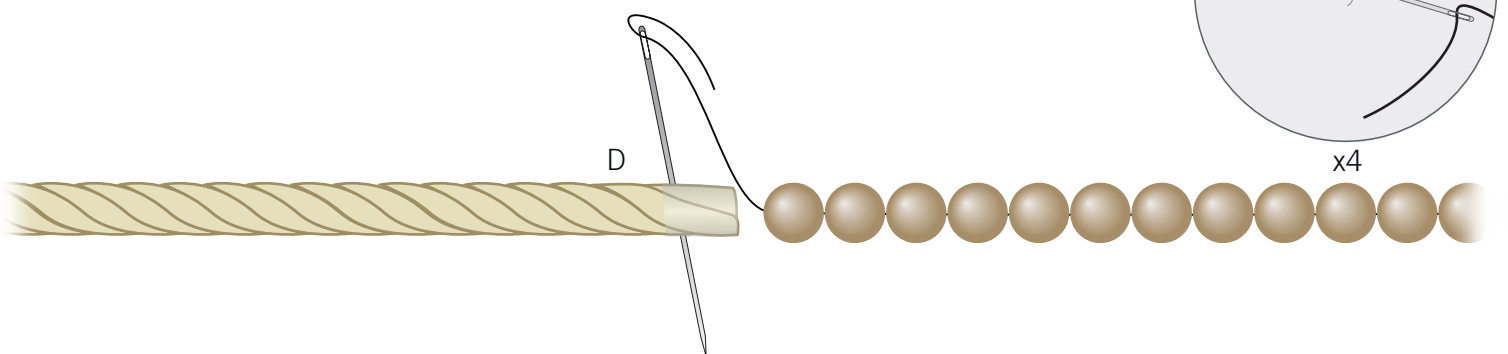

STEP 5



0.3 mm

60 cm

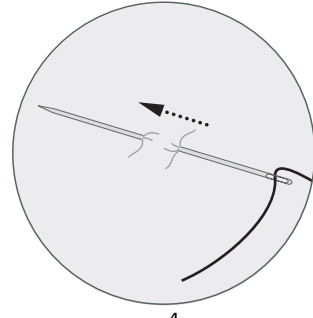

x4



Scale 1:2

STEP 6

Repeat steps 4 - 5 (C):

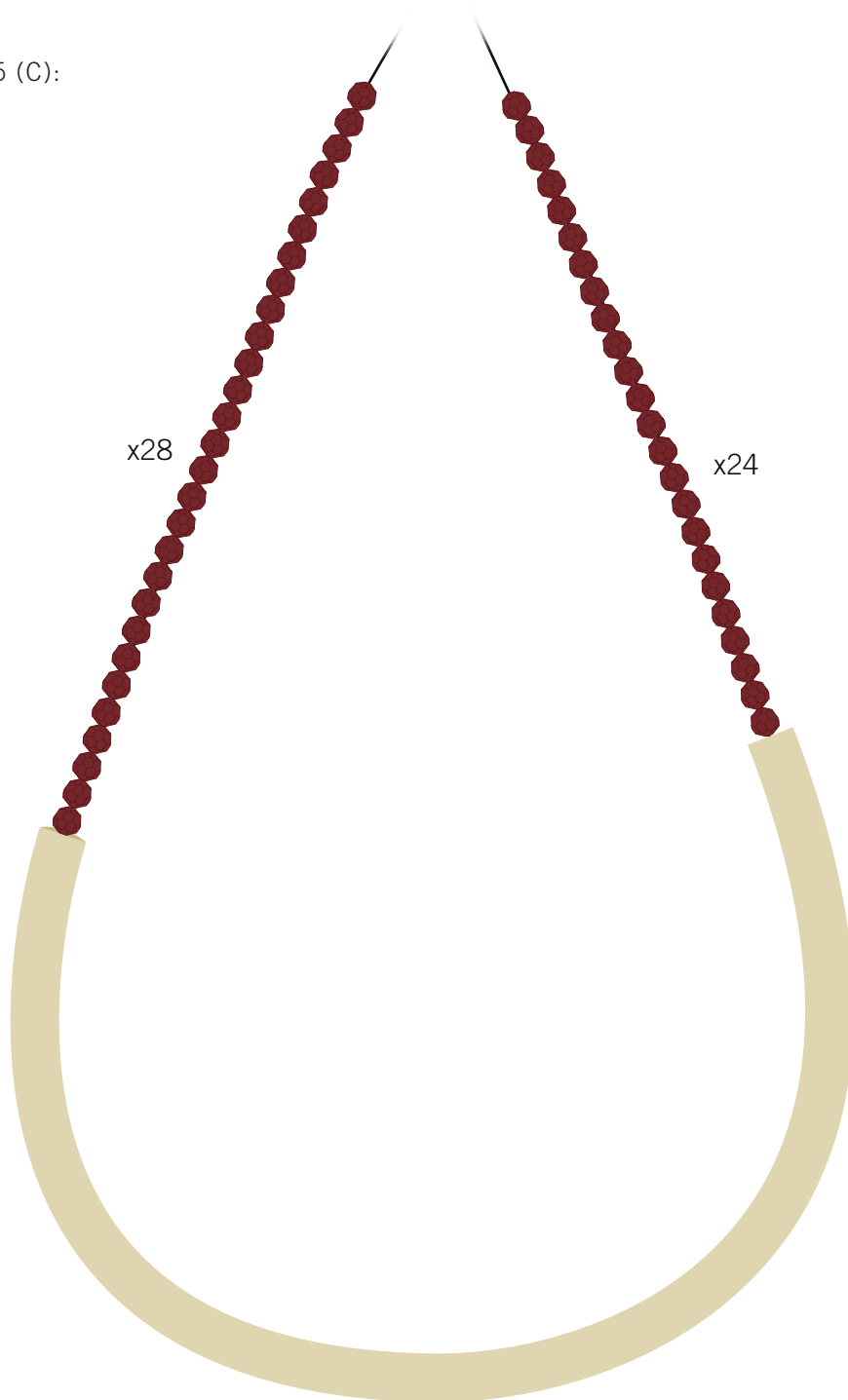

Scale 1:2

STEP 7



Repeat



STEP 8

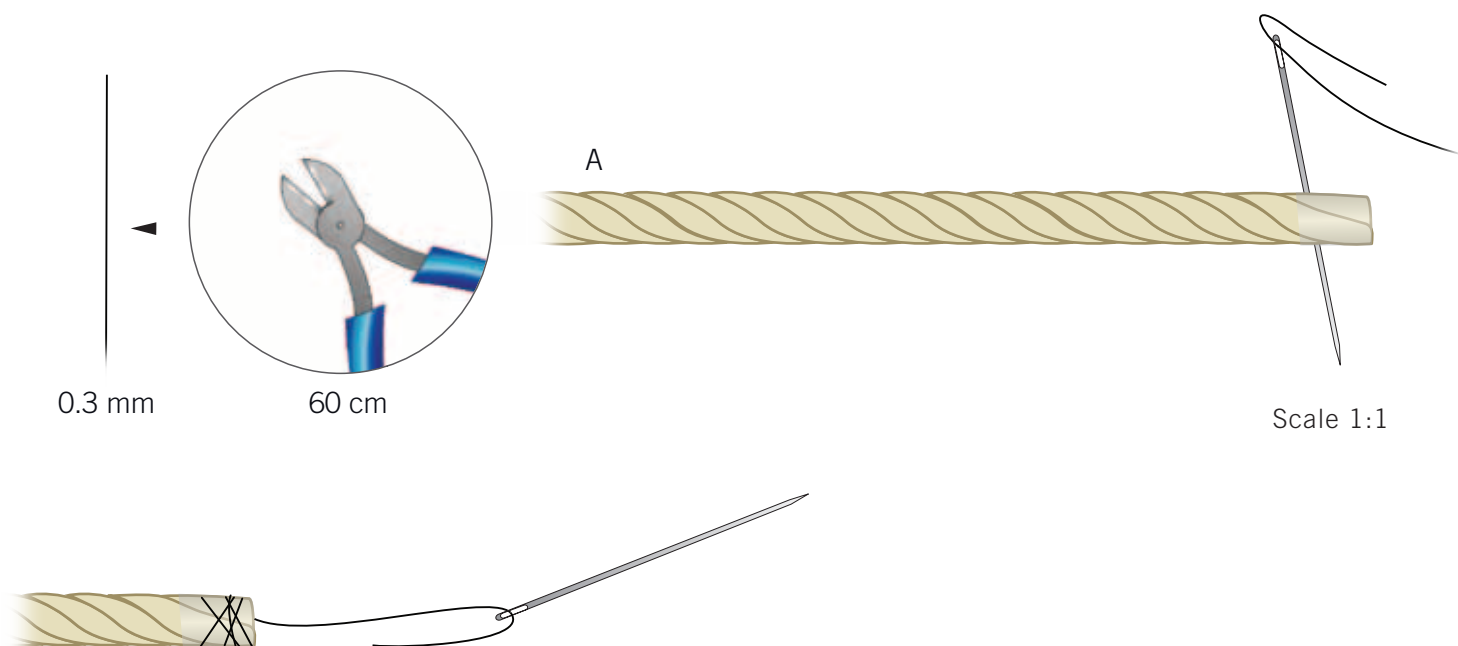

STEP 9

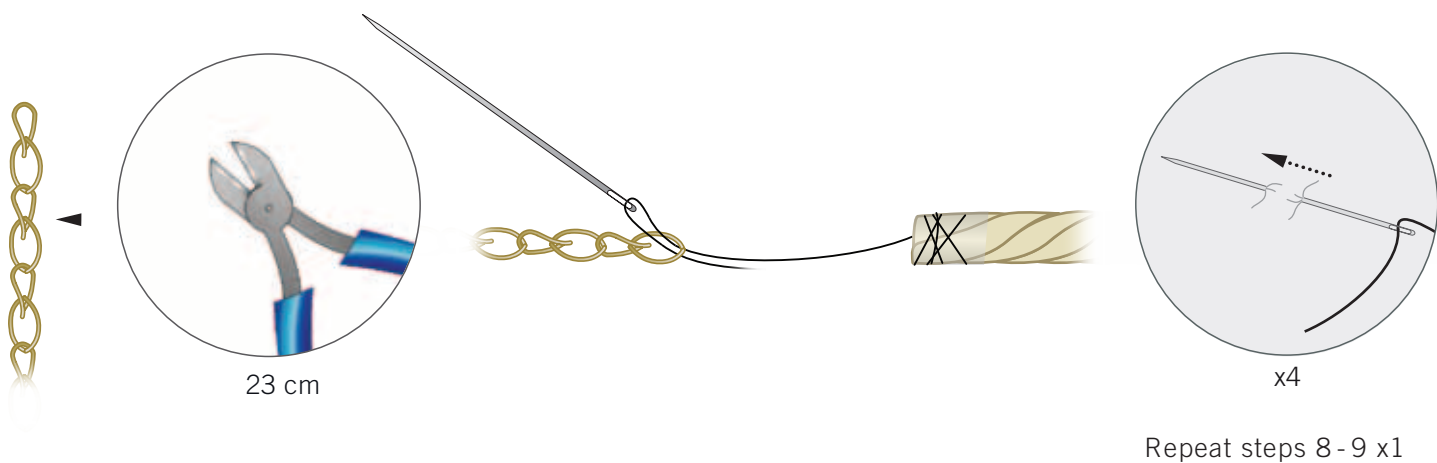

STEP 10

Repeat steps 8-9 x1 (B):



STEP 11

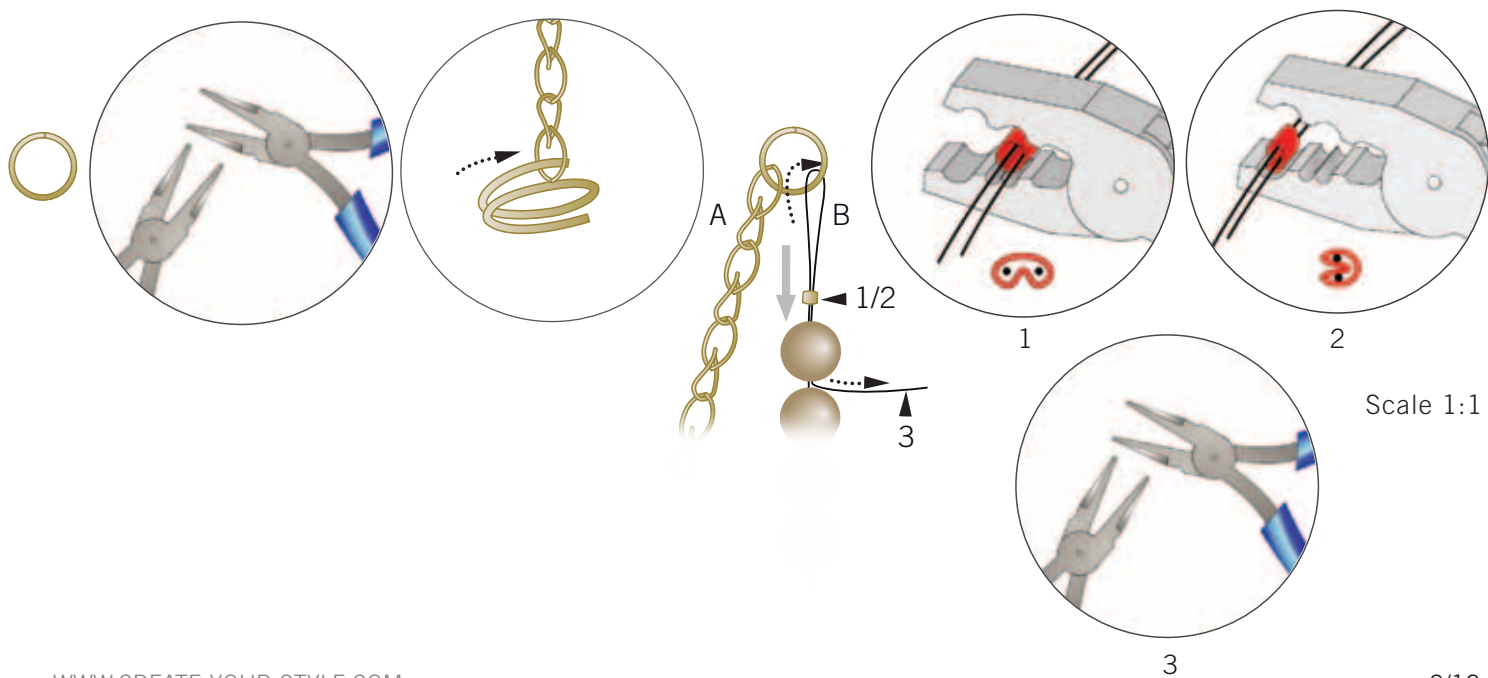

Repeat step x1:

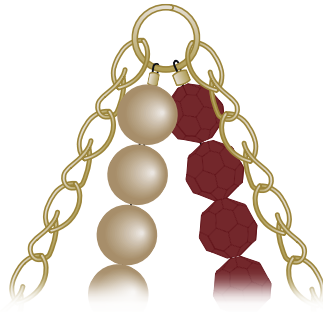

STEP 12

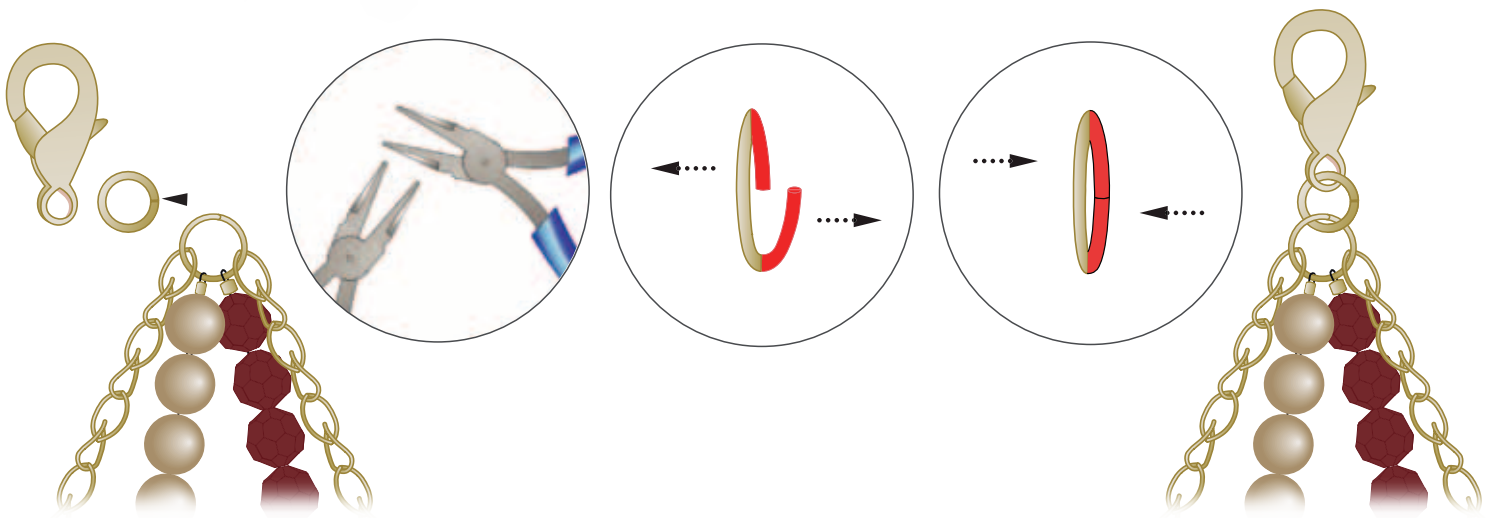

STEP 13

Repeat steps 11 - 12 x1:

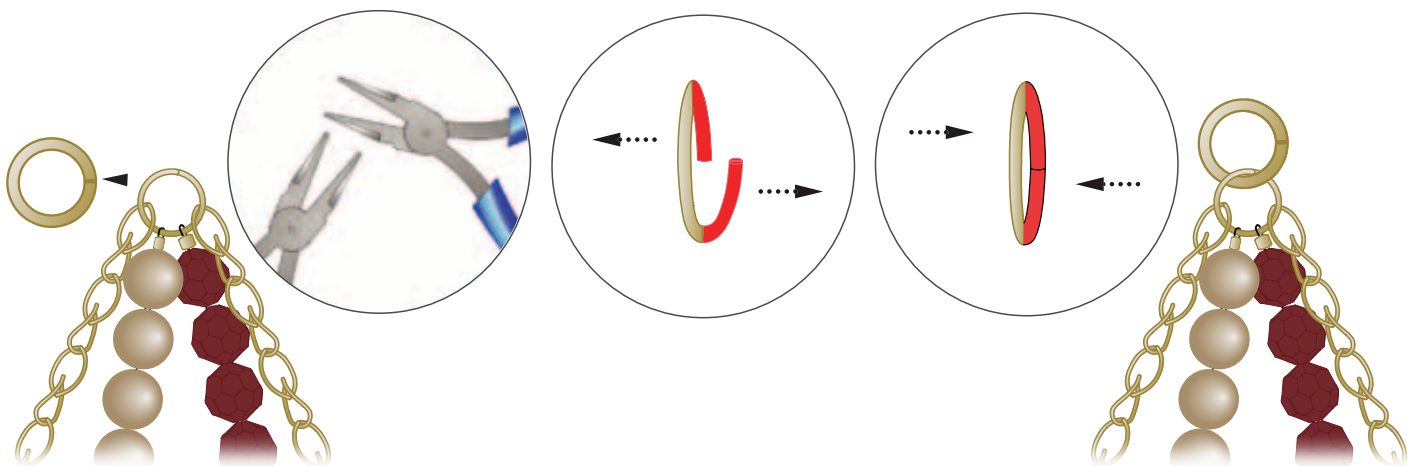



Scale 1:2

SUMMER HOLIDAYS NECKLACE "SAND DUNE"



- STEP 1: Cut the different fabrics in diagonal shape (selvedge run of thread should go diagonal) to stripes, this is depicted with the diagonal shape of the arrows on different fabric pieces in the illustrations in this step. Cut the fabrics to the sizes mentioned which are Brown (A) 47x4.5 cm, Copper (B) 26x4.5 cm, Sand (C) 32x4.5 cm and Red (D) 40x4.5 cm.
- STEP 2: Fold the fabric piece into half and sew it with a sewing machine 10 mm from the edge as shown in the illustration. Cut half of this seam off which should be about 5 mm in size. Repeat this step with the other three fabric pieces as well.
- STEP 3: Thread a needle with 50 cm of button silk and tie a knot at the ends as shown in the illustrations. Begin sewing at one of the ends of the fabric with 2 back stitches and stitch the needle backwards through the fabric piece turning it as you go. Repeat this step 3 more times to the other three fabric pieces.
- STEP 4: Cut the hemp ribbon for brown fabric A. 44 cm, copper B. 23 cm, Sand C. 29 cm, Red D. 37 cm. Cut 60 cm of 3 mm tiger tail using a side cutter. Secure one end with a piece of tape and slide on 22 Swarovski Crystal Pearls art. 5810 Crystal Antique Brass Pearl. Thread the end of the tiger tail onto the sewing needle and stitch through one end of the hemp ribbon D. 37 cm and affix with 4 back stitches.
- STEP 5: Thread the other end of the hemp through the red ribbon. Cut 60 cm of tiger tail and thread onto the needle. Pierce through this end of the hemp ribbon and fix the tiger tail with back stitches. Stitch through to the top of the hemp and insert 25 Swarovski Crystal Pearls art. 5810 Crystal Antique Brass Pearl to this end.
- STEP 6: Repeat steps 4 – 5 with the hemp ribbon C. 29 cm and sand ribbon piece. Insert on one end 24 Swarovski Beads art. 5000 8 mm Garnet on both sides as shown in the illustration with this step.
- STEP 7: Wind a piece of tape around one of the ends of the red ribbon to facilitate the movement of Swarovski Fancy Stones and the 12 mm jump rings. The components should be in the following order from right to left:
- Jump ring x3 – Swarovski Fancy Stone art. 4139 14 mm Crystal Copper x1 – Jump ring x6 – Swarovski Fancy Stone art. 4439 Crystal Red Magma x1 – Jump ring x6 – Swarovski Fancy Stone art. 4139 14 mm Crystal Golden Shadow x1 – Jump ring x2 – Swarovski Fancy Stone art. 4137 22x16 mm Crystal Tabac x1 – Jump ring x1 – Swarovski Fancy Stone art. 4139 14 mm Crystal Red Magma x1 – Jump ring x3 – Swarovski Fancy Stone art. 4137 22x16 mm Crystal Red Magma x1 – Jump ring x13 – Swarovski Fancy Stone art. 4139 14 mm Crystal Sahara x1 – Jump ring x14 – Swarovski Fancy Stone art. 4439 20 mm Crystal Sahara x1 – Jump ring x5 – Swarovski Fancy Stone art. 4139 14 mm Crystal Red Magma x1 – Jump ring x12 – Swarovski Fancy Stone art. 4139 14 mm Crystal Copper x1 – Jump ring x3 – Swarovski Fancy Stone art. 4137 22x16 mm Crystal Red Magma x1 – Jump ring x9 – Swarovski Fancy Stone art. 4139 14 mm Crystal Tabac x1 – Jump ring x10 – Swarovski Fancy Stone art. 4439 20 mm Crystal Red Magma x1 – Jump ring x4 – Swarovski Fancy Stone art. 4139 14 mm Crystal Sahara x1 – Jump ring x8 – Swarovski Fancy Stone art. 4139 14 mm Crystal Copper x1 – Jump ring x1
- STEP 8: Cut 60 cm of 0.3 mm tiger tail with a side cutter and use hemp ribbon A for the brown fabric. Stitch through one end of the hemp ribbon and fix the tiger tail with 4 back stitches and come out on top.
- STEP 9: Cut 23 cm of chain and fix it with four back stitches coming out of the hemp ribbon. Repeat steps 8 – 9 to fix the other end of this hemp ribbon with another piece of chain.
- STEP 10: Repeat steps 8 – 9 with hemp ribbon B and copper fabric as shown in the illustrations with this step.
- STEP 11: Attach chain with the brown ribbon to the split ring shown as A, in the illustrations and the pearl string with red ribbon shown as B in the illustrations. For the pearl string slide a crimping tube on the tiger tail and go through the split ring, back through the crimping tube and then through one of the Swarovski Crystal Pearls art. 5810. Pull the tiger tail tightly, crimp the crimping tube and cut off the leftover tiger tail as shown. Repeat this step one more time to fix the chain with the auburn ribbon and the beaded string with the sand ribbon as shown.
- STEP 12: Attach the lobster clasp with an 8 mm jump ring onto the split ring.
- STEP 13: Repeat steps 11 – 12 one more time to fix the other string ends as well. Connect a 12 mm jump ring to the split ring.