

CREATE
YOUR STYLE
with SWAROVSKI ELEMENTS



DESIGN PROJECT
SUMMER HOLIDAY
SUN CAP
SUMMER BREEZE

SUN CAP "SUMMER BREEZE"



SWAROVSKI ELEMENTS

Article	Product Group	Article No.	Amount	Size	Colour	Colour Code
	Sew-on Stones	3265	1 pc.	26x21 mm	Crystal Volcano	001 VOL
	Fancy Stones	4439	1 pc.	14 mm	Crystal Tabac	001 TAB
	Beads	5005	1 pc.	12 mm	Light Topaz	226
	Pendants	6690	1 pc.	23 mm	Capri Blue	243
	Pendants	6790	1 pc.	30 mm	Aquamarine	202
	Pendants	6790	1 pc.	30 mm	Jet	280
	Pendants	6790	1 pc.	40 mm	Crystal Red Magma	001 REDM

Supplies & Tools

Supplies

1x Jersey, violet, 5x95cm
 1x Jersey, green, 150x60cm
 1.5 m Nylon thread, transparent,
 Ø 0.25 mm
 2x Plastic folder, yellow, DIN A4
 0.35 m Ribbon cotton, yellow, Ø 3 cm
 Sewing silk, yellow, violet

Tools

Double sided sticky tape
 Needle
 Paper, DIN A4
 Pins
 Scissors
 Sewing machine

Level of design: INTERMEDIATE

Have also a look at the **text instruction** at the last page!

STEP 1

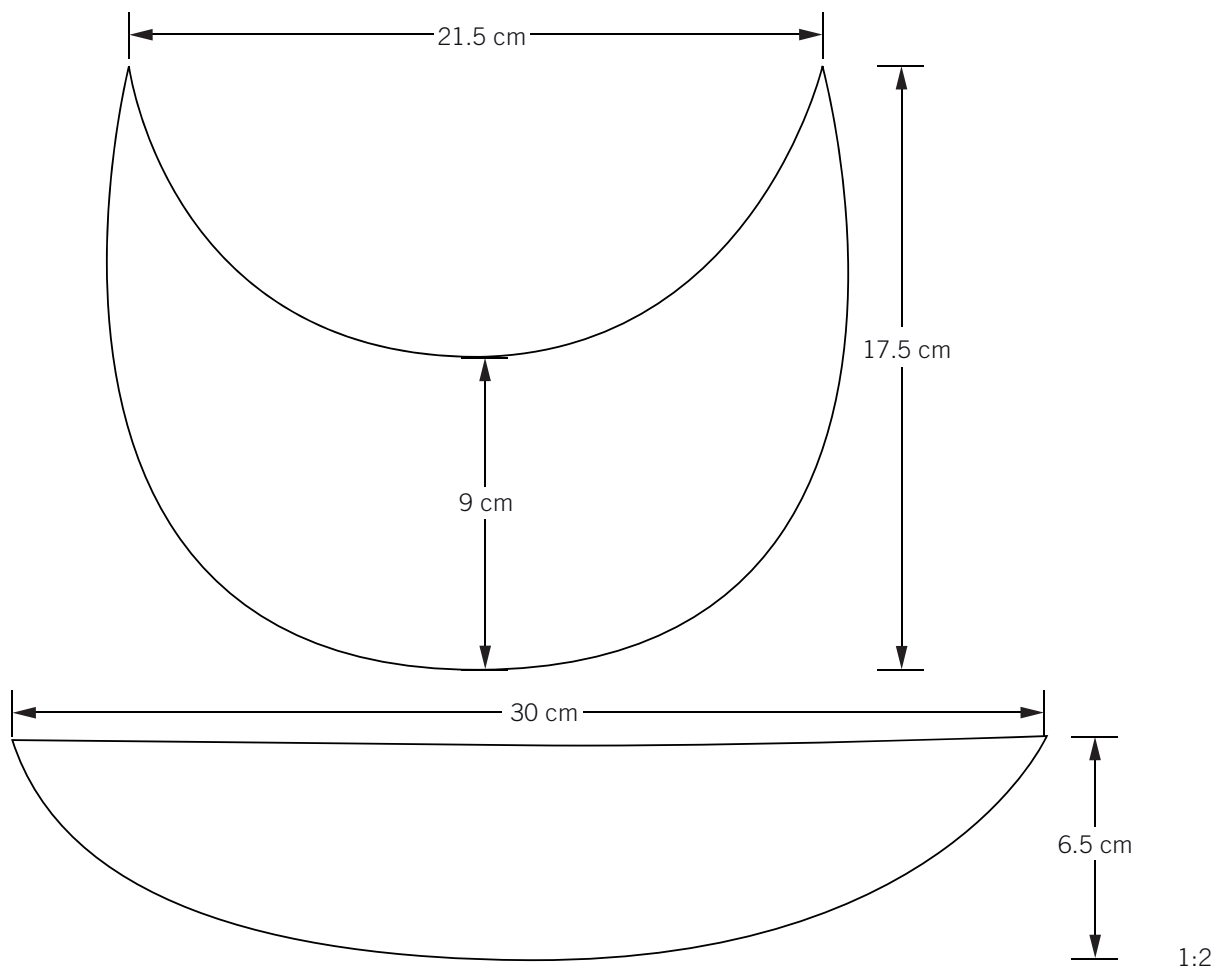

STEP 2

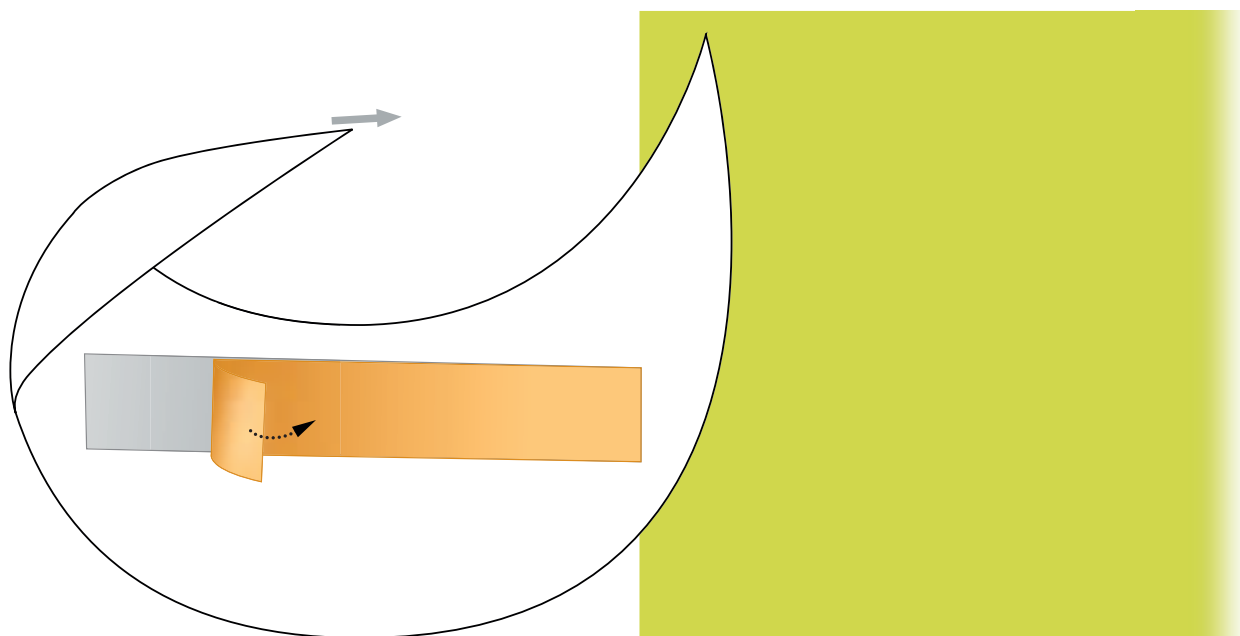

Repeat x1

STEP 3

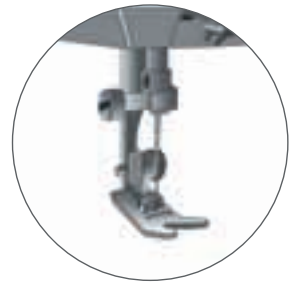
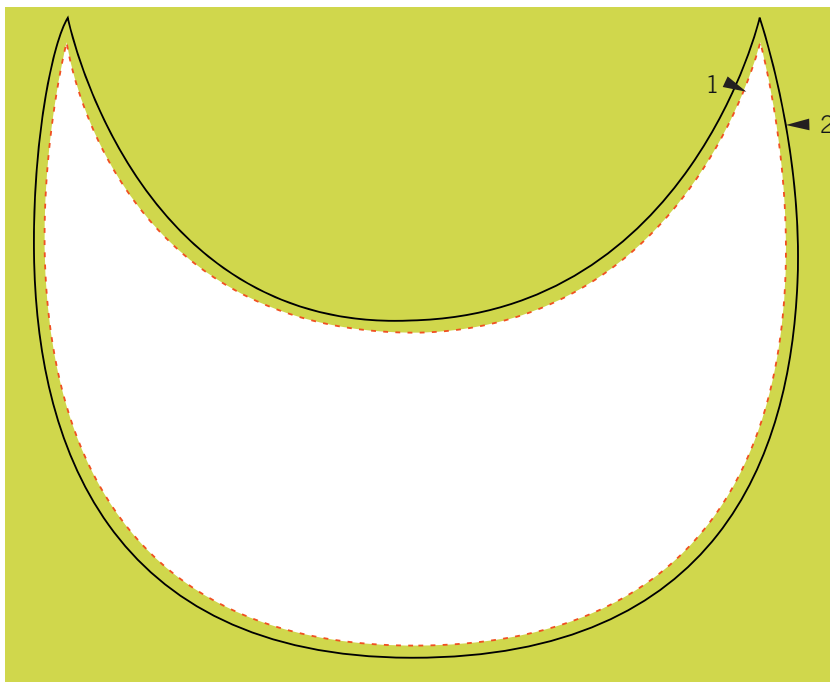

1



2

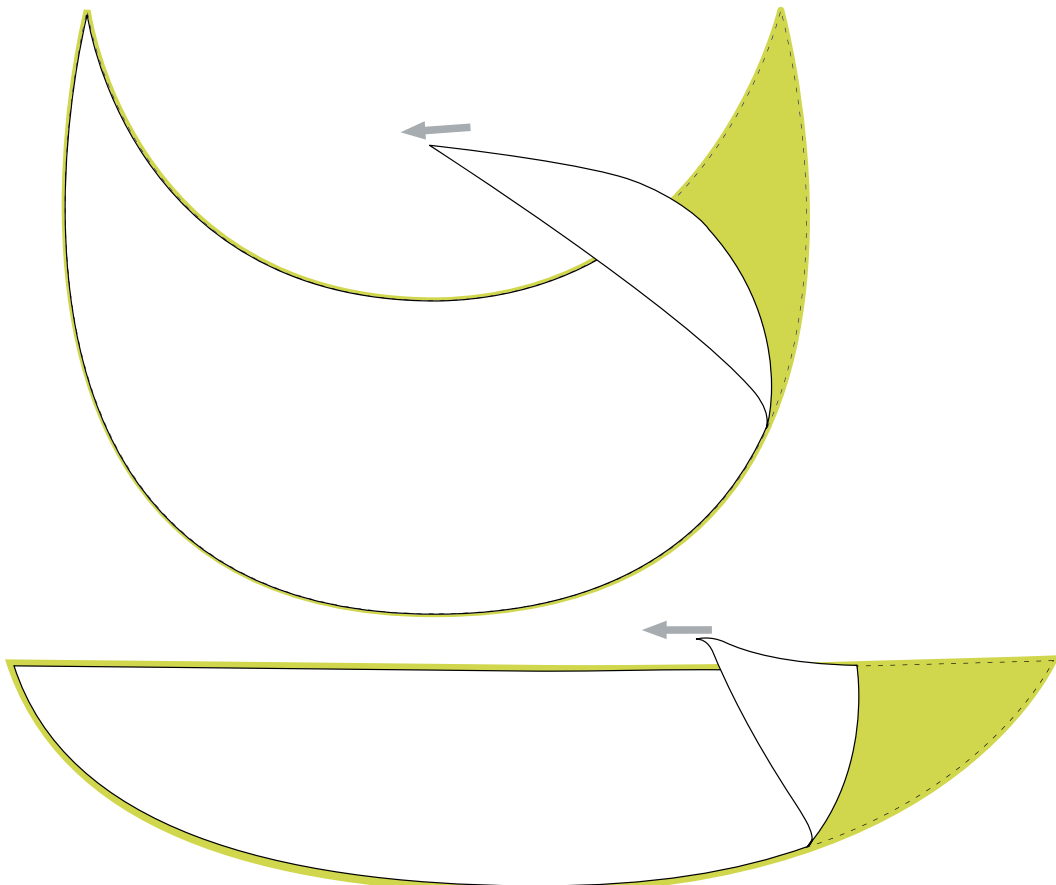
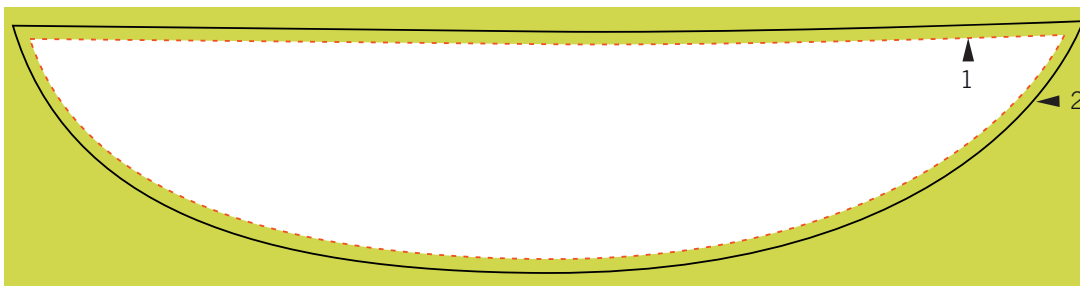

STEP 4



5 cm

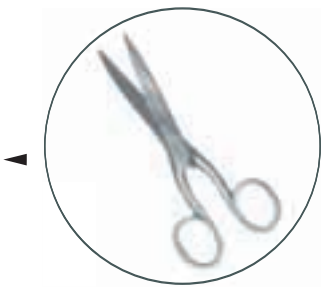

35 cm

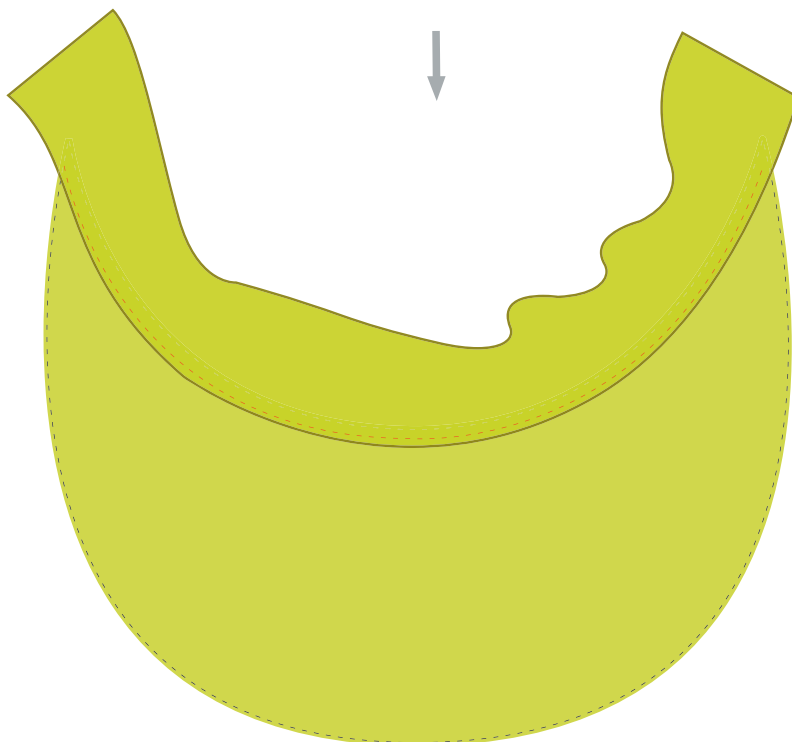
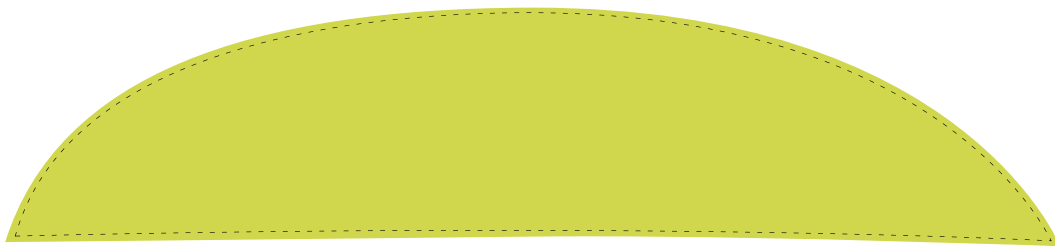
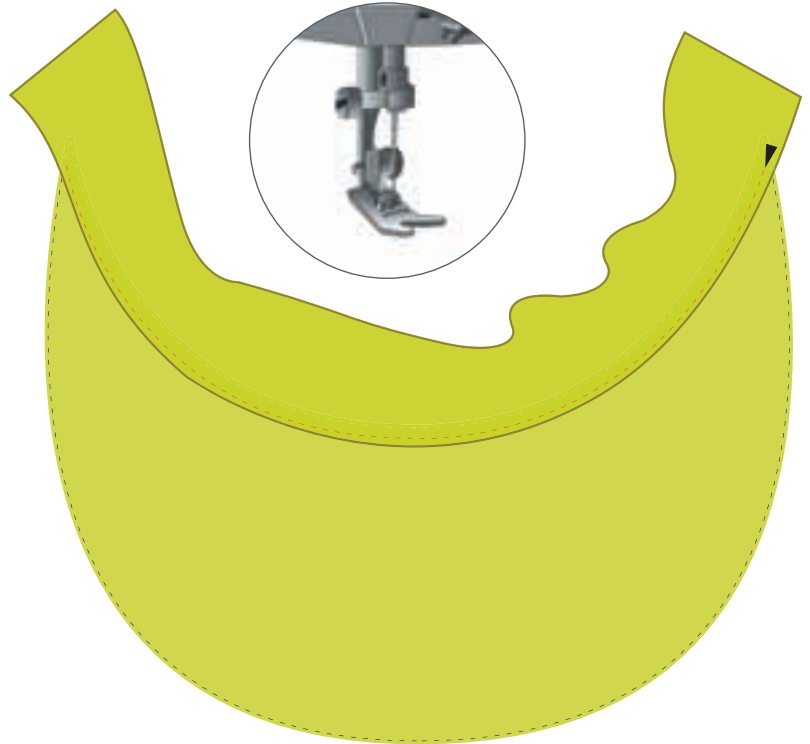
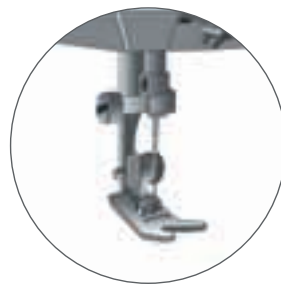

STEP 5

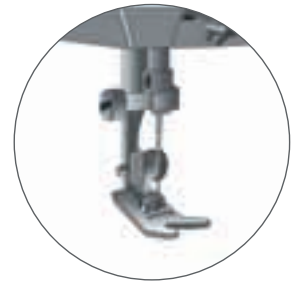
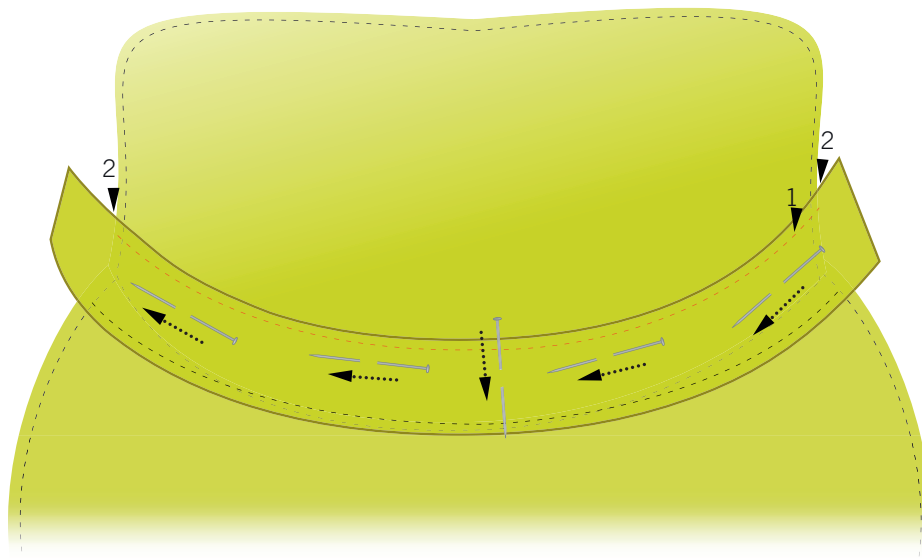

1



2

STEP 6

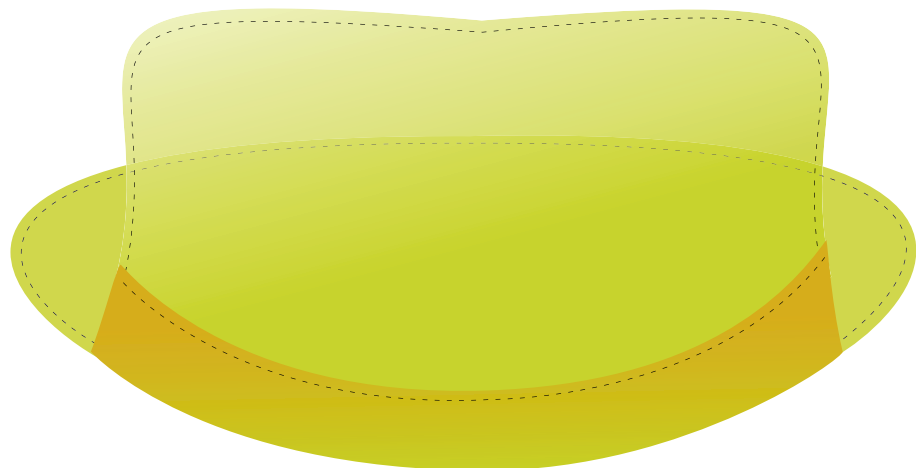

STEP 7

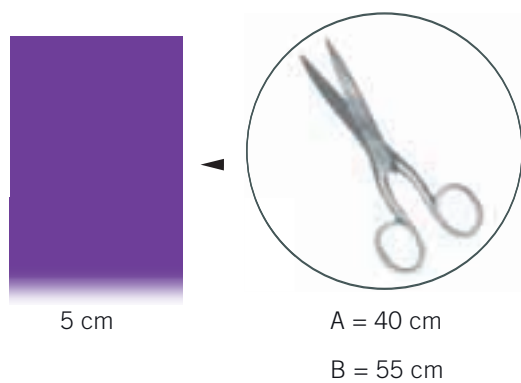

STEP 8

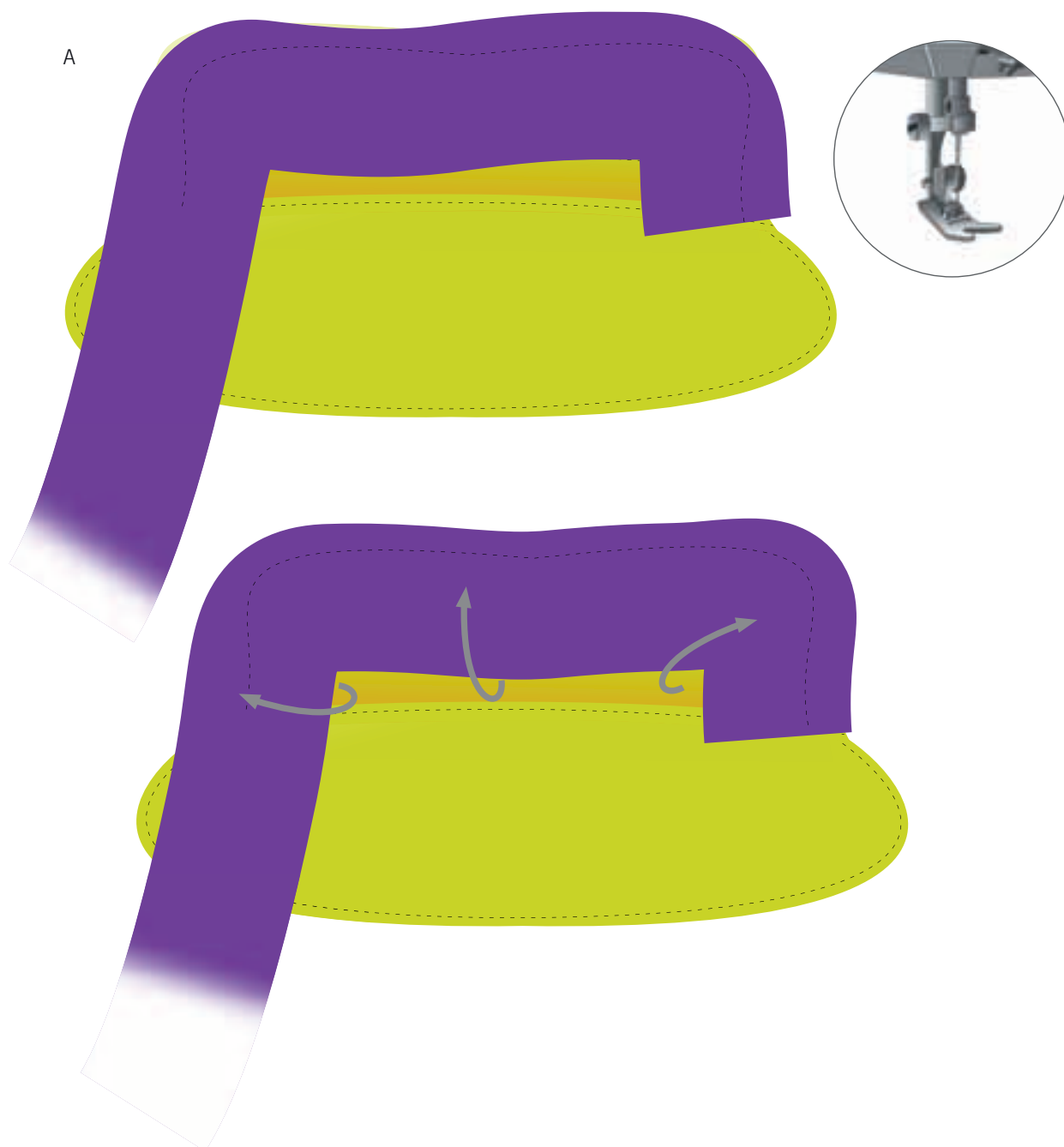

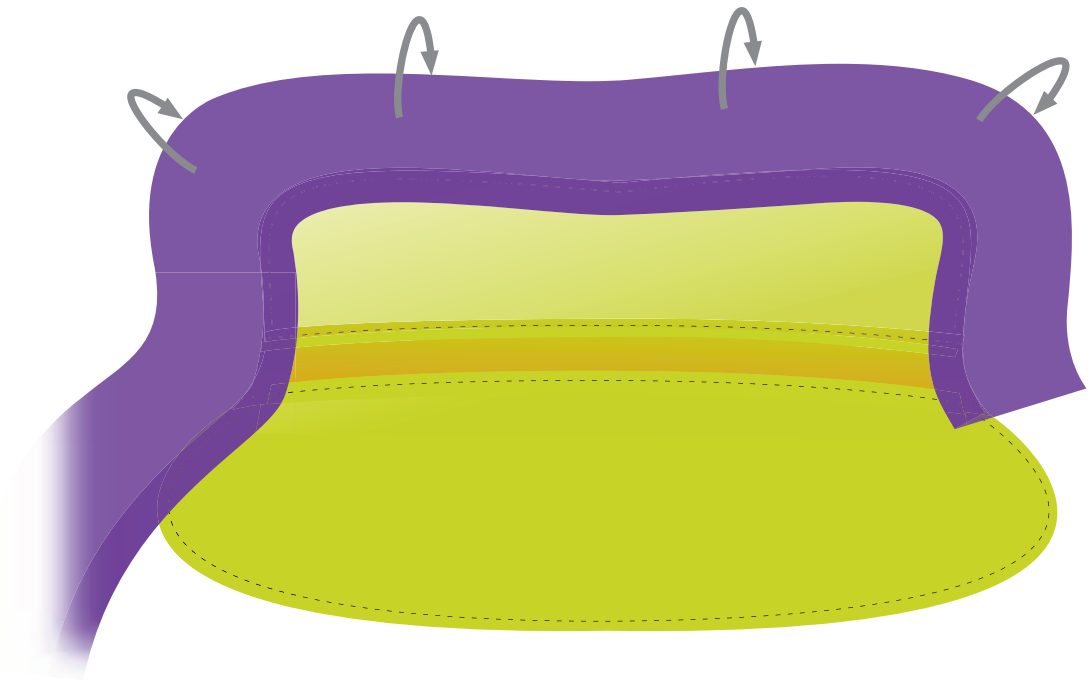

STEP 9

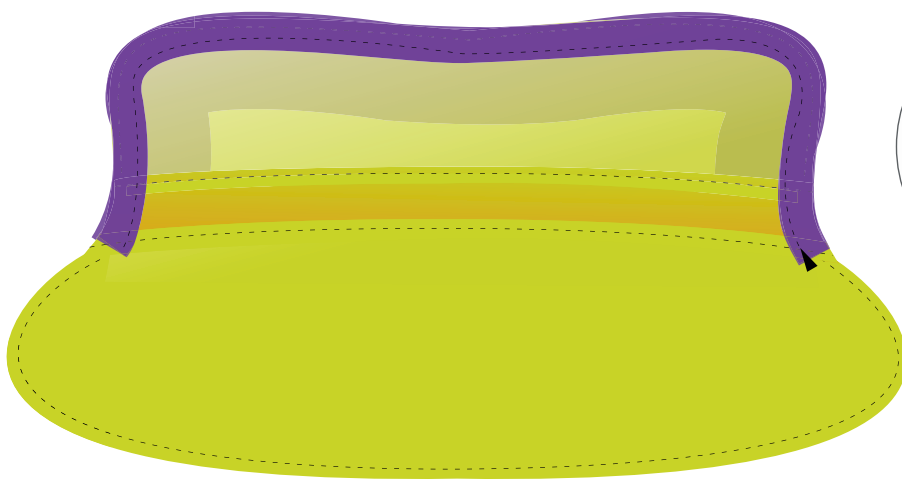

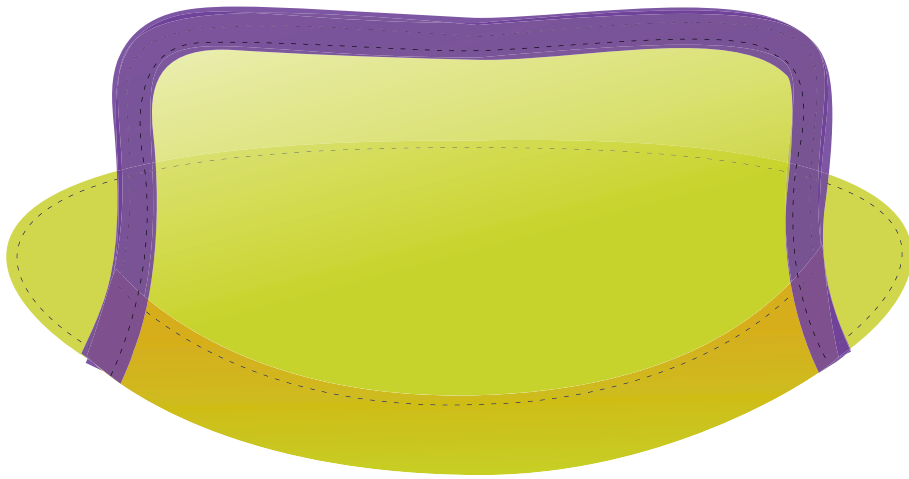

Repeat steps 8 - 9:

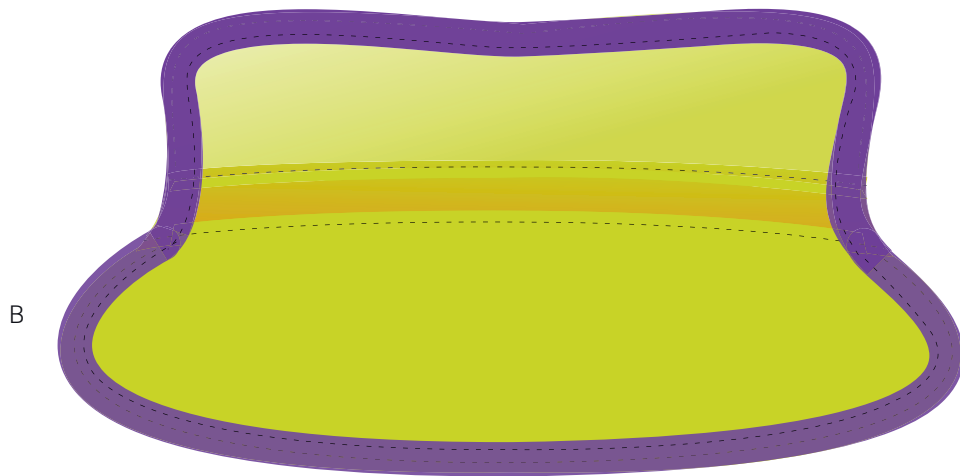

STEP 10



17cm



150 cm x3

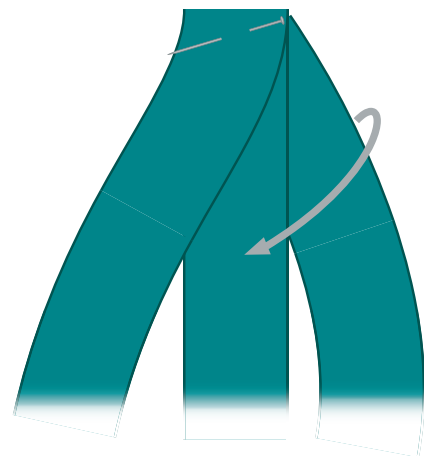

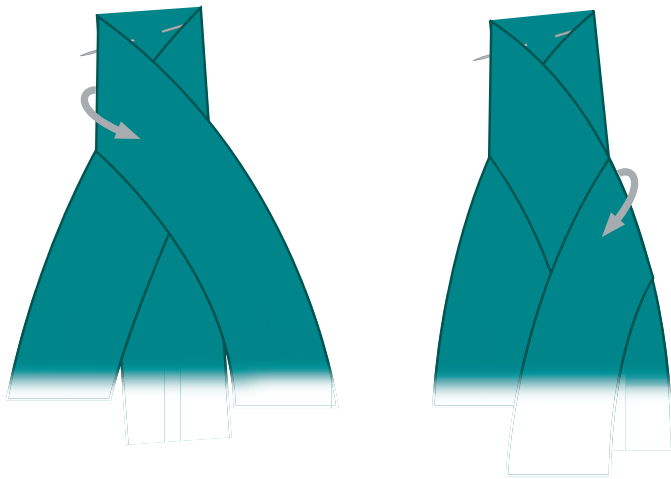

Repeat

STEP 11

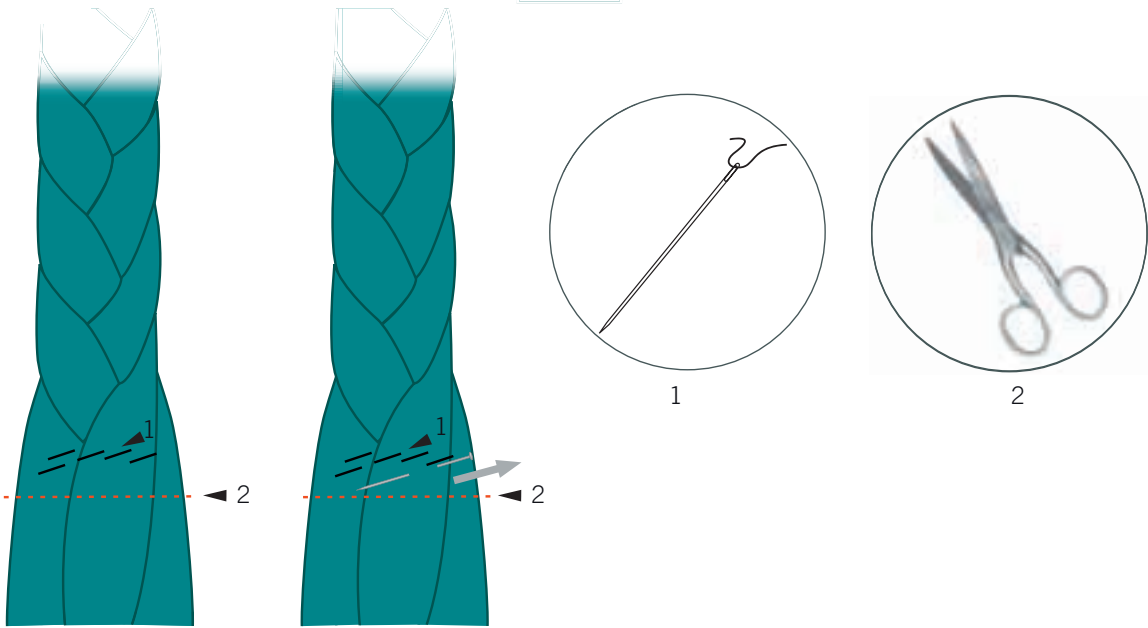

STEP 12

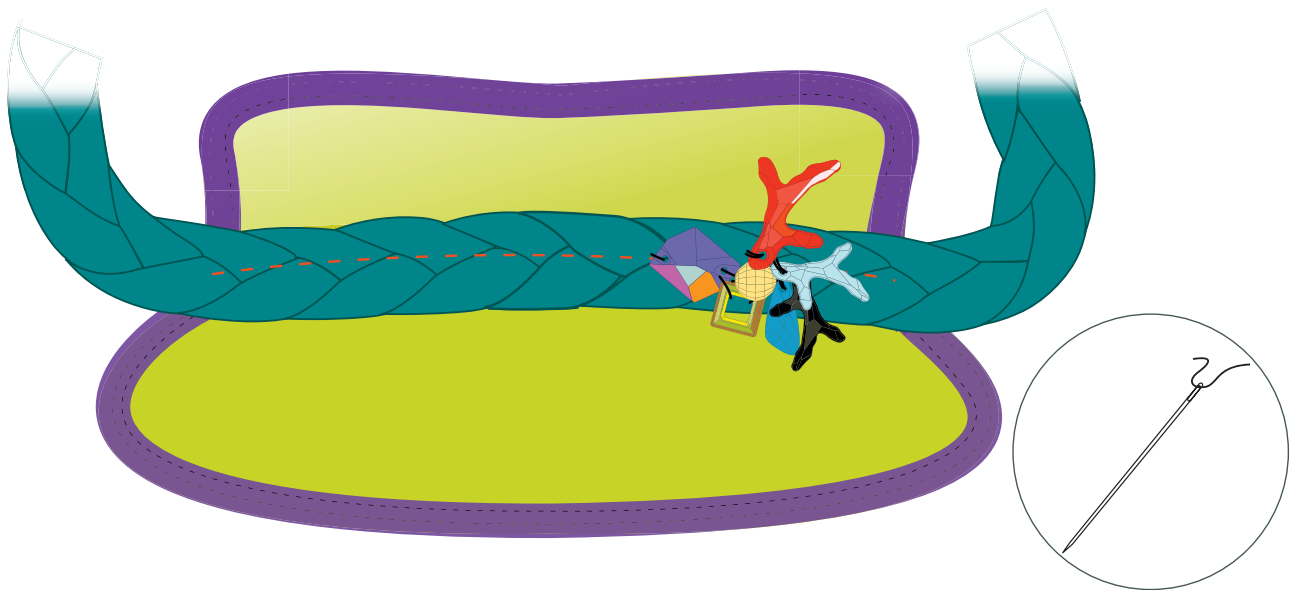

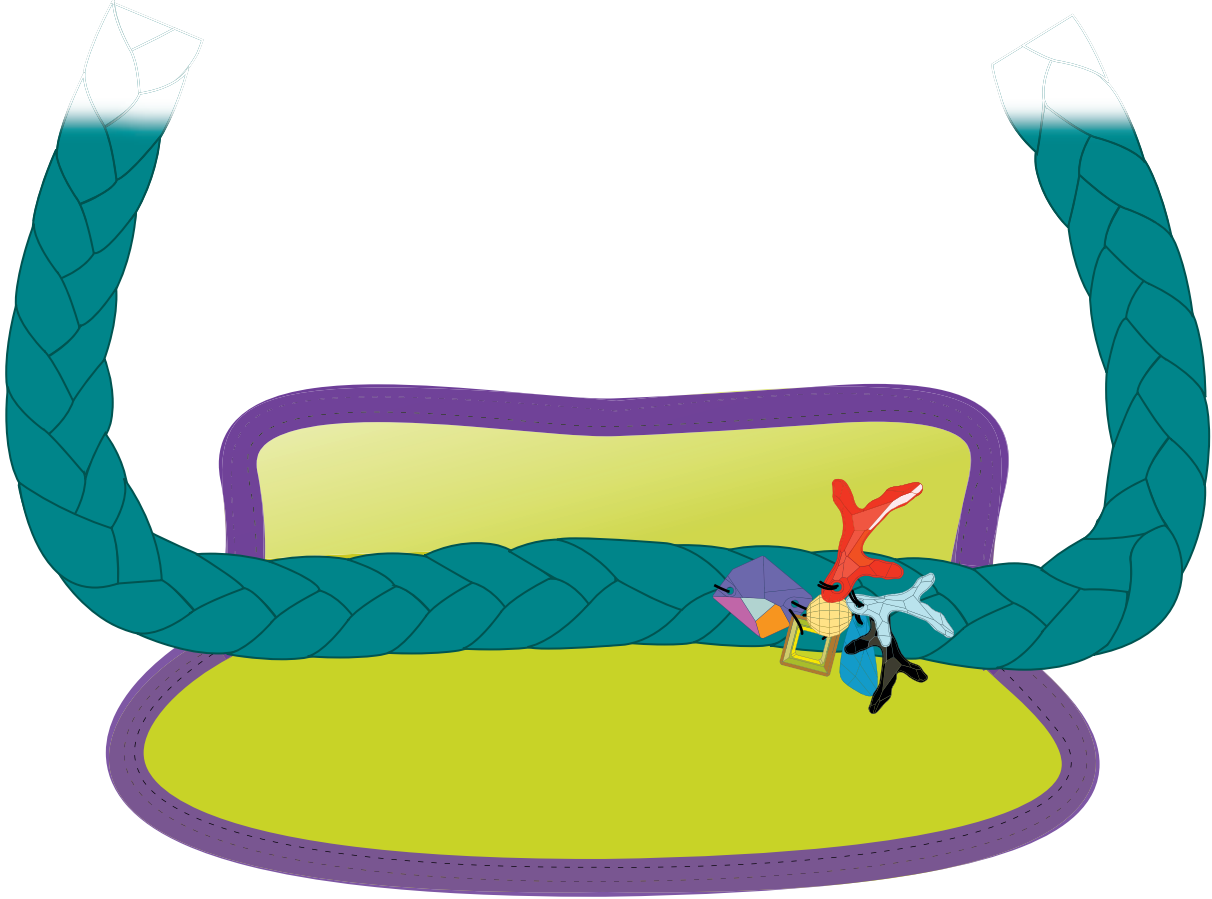

CREATE YOUR STYLE Design Project
Summer Holiday Sun Cap “Summer Breeze”

- STEP 1: Print out the pattern with measurements as shown in the illustration and cut out along outline (make sure to increase size to measurement 1:1).
- STEP 2: Put some double sided sticky tape onto both patterns and stick each onto a plastic folder (use each plastic folder double as it is).
- STEP 3: Use sewing machine and sew exactly along the outline of both patterns and cut out parts leaving a 1 mm border next to seam. Remove the paper pattern.
- STEP 4: Cut 35cm of 5cm Ribbon and sew it onto the first pattern as you see in illustration.
- STEP 5: Sew both patterns with ribbon as you see in illustration. Cut off excess ribbon with scissors.
- STEP 6: Turn the cap over.
- STEP 7: Cut 2 pieces of violet jersey: A 40cm and B 55cm
- STEP 8: Start with jersey A and sew the jersey onto the top part of the front side of the cap. Sew a border of 1 cm around the cap. Then turn jersey to back side.
- STEP 9: To fix jersey on both sides sew with sewing machine along border as you see in illustration (black dotted line). On back side cut off jersey after sewing. Repeat Steps 8 – 9 once with jersey B.
- STEP 10: Cut 3 pieces of 150cm of green jersey and fold each piece over 3 times. Attach all 3 pieces with a pin and start braiding as you see in illustration.
- STEP 11: Braid to the end and fix ends with a pin, then attach the beginning and the end with invisible stitches using needle and nylon thread.
- STEP 12: Sew the braided jersey piece onto the cap with needle and nylon thread. Then sew the SWAROVSKI ELEMENTS onto the jersey as you see in the illustration.