

CREATE
YOUR STYLE
with SWAROVSKI ELEMENTS





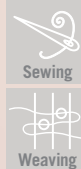

DESIGN PROJECT

VALENTINE'S DAY
GIFT BOX
"HEART"

VALENTINE'S DAY GIFT BOX "HEART"



SWAROVSKI ELEMENTS

Article	Product Group	Article No.	Amount	Size	Color	Color Code
	Beads	5000	22 pcs.	4 mm	Fuchsia	502
	Beads	5000	5 pcs.	4 mm	Olivine	228
	Beads	5742	2 pcs.	8 mm	Light Rose	223
	Beads	5742	2 pcs.	10 mm	Siam	208
	Beads	5744	4 pcs.	6 mm	Light Siam	227
	Beads	5744	1 pc.	8 mm	Sunflower	292
	Beads	5752	1 pc.	8 mm	Light Rose	223
	Beads	5752	1 pc.	8 mm	Light Siam	227
	Beads	5752	1 pc.	12 mm	Light Siam	227
	Beads	5754	1 pc.	8 mm	Sunflower	292

Supplies & Tools

Supplies

- 1x Cardboard, red, Ø 12.5cm
- Cotton Yarn, rose, 3 m
- 1x Paper Box, white, Ø 12.5cm
- Ribbon satin, fuchsia, 0.8cm, 40cm
- Ribbon velvet, green, 2.3cm, 40cm
- Rubber tube, transparent, Ø 0.5cm, 37cm

Tools

- Beading needle
- Cardboard, 10x10 cm
- Cutter
- Double sided tape
- Needle
- Pencil
- Scissors
- Sheet of paper, A4
- Tape
- White pencil

Level of design: INTERMEDIATE

Have also a look at the **text instruction** at the last page!

STEP 1

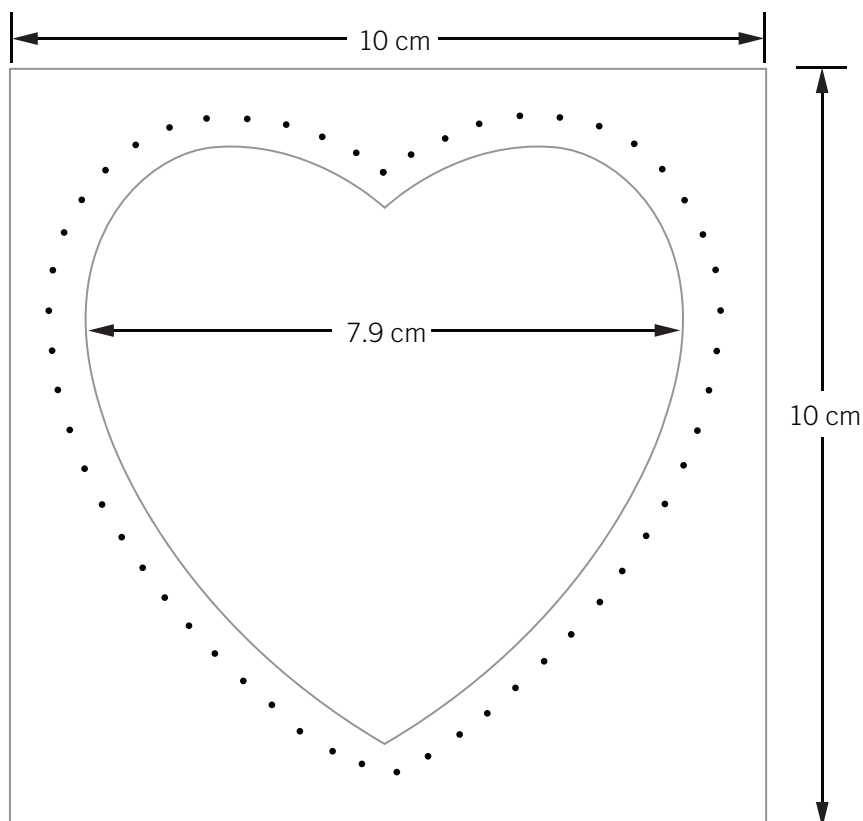

STEP 2

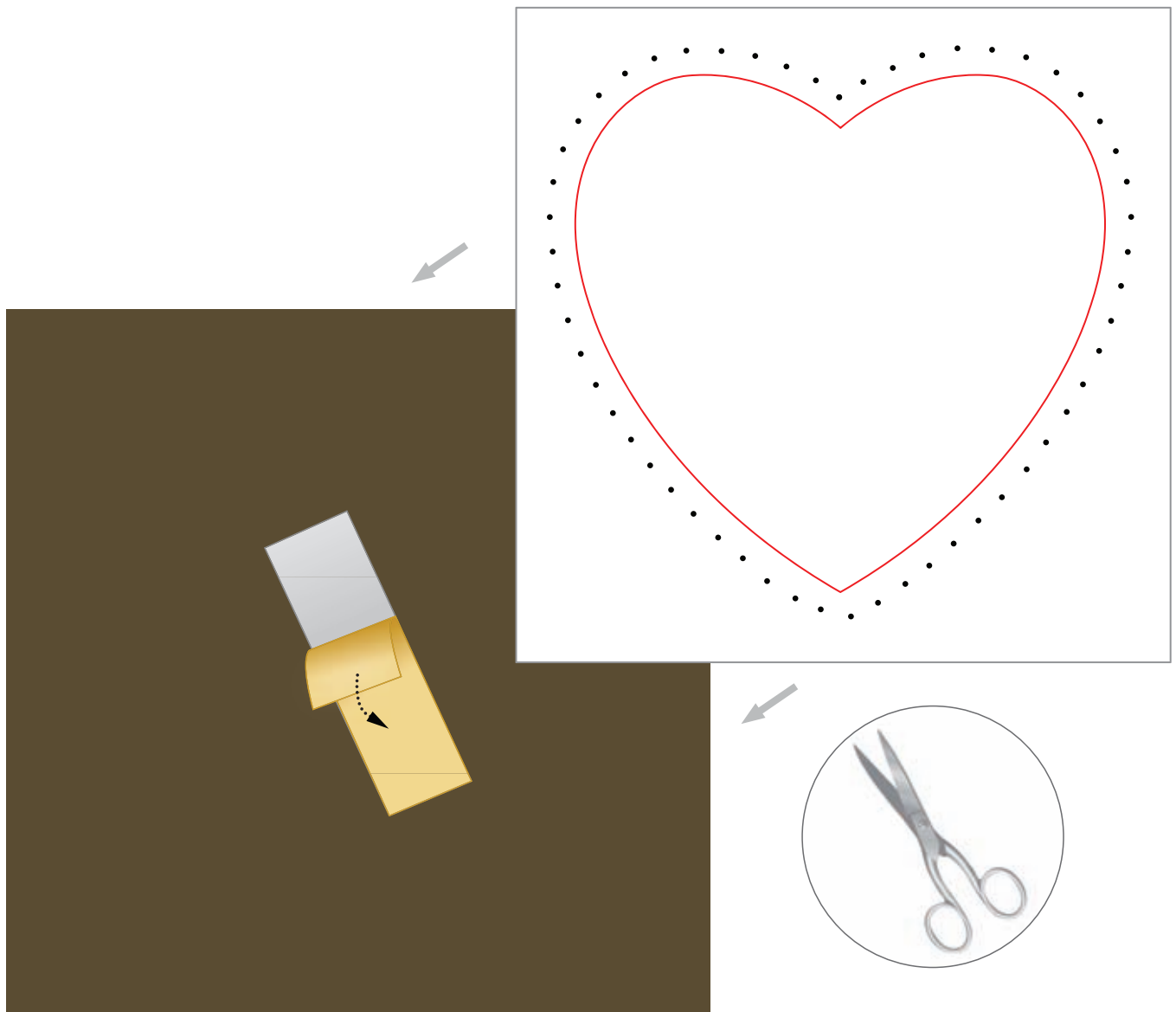

STEP 3

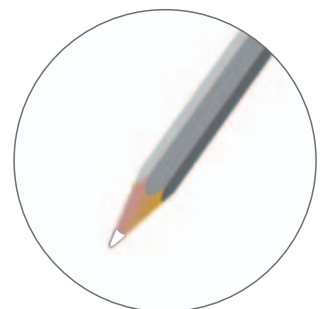
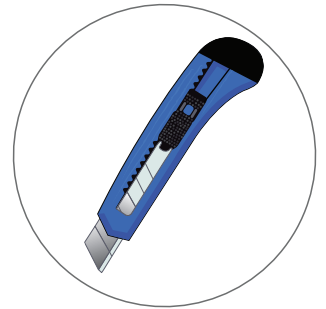
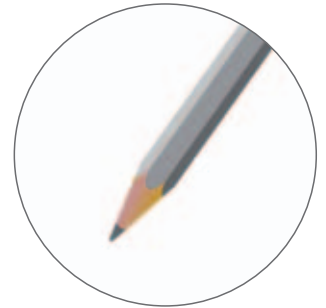
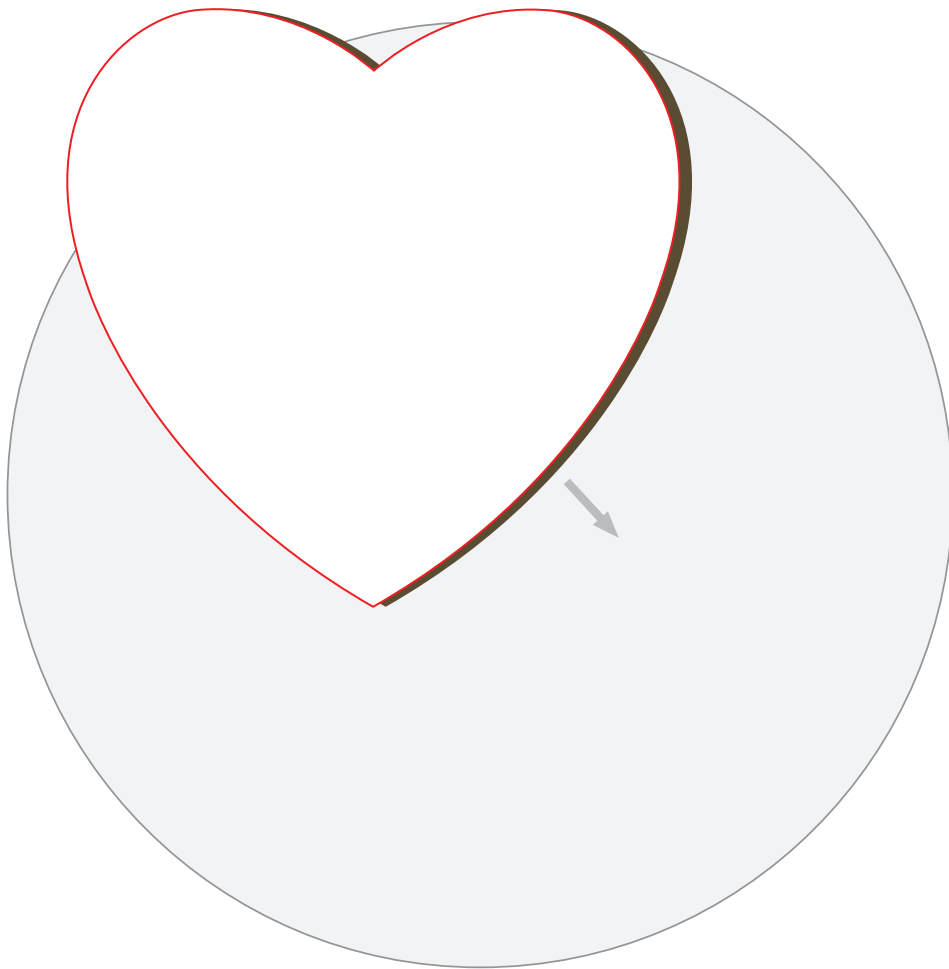

STEP 4

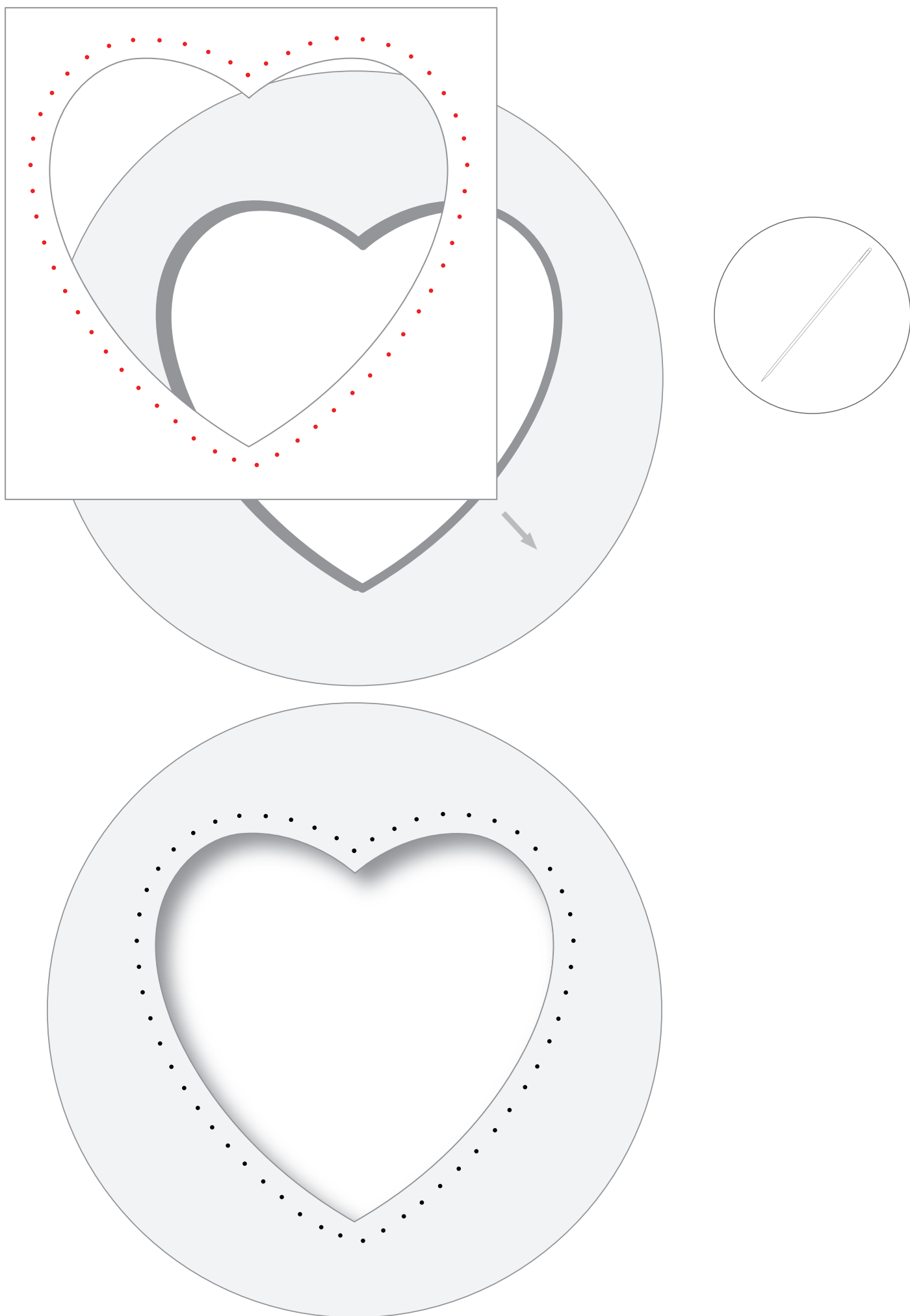

STEP 5

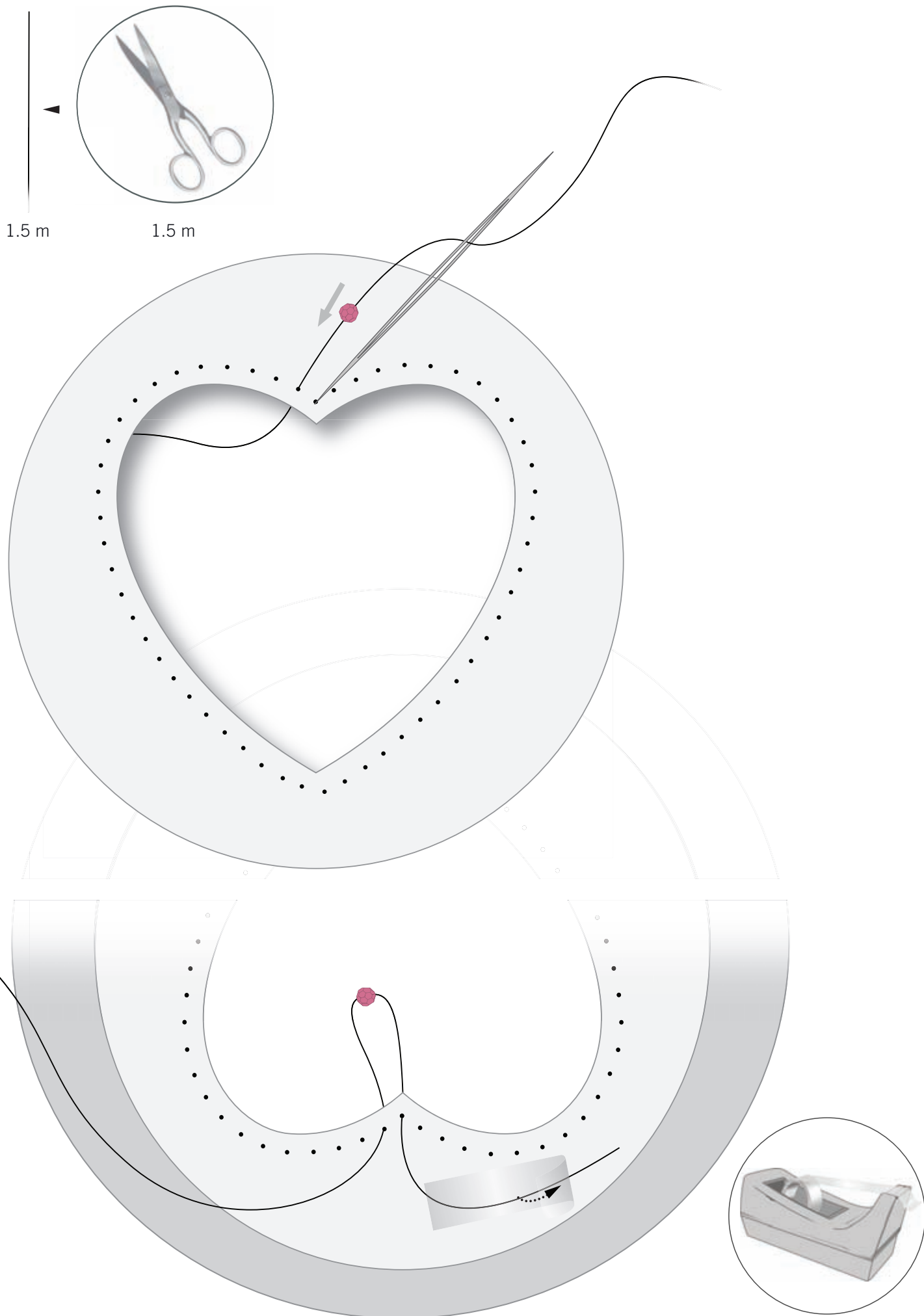

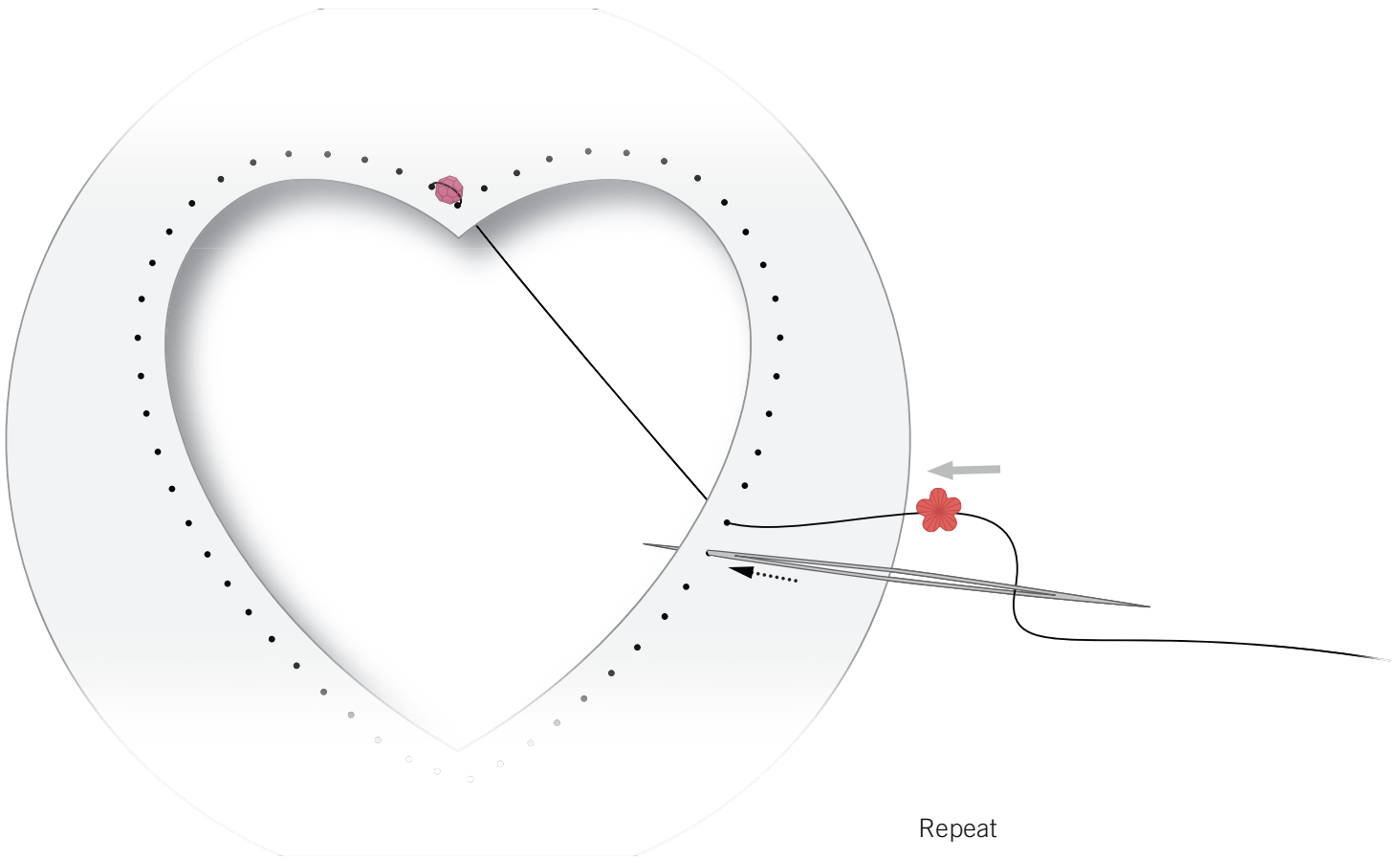

STEP 6

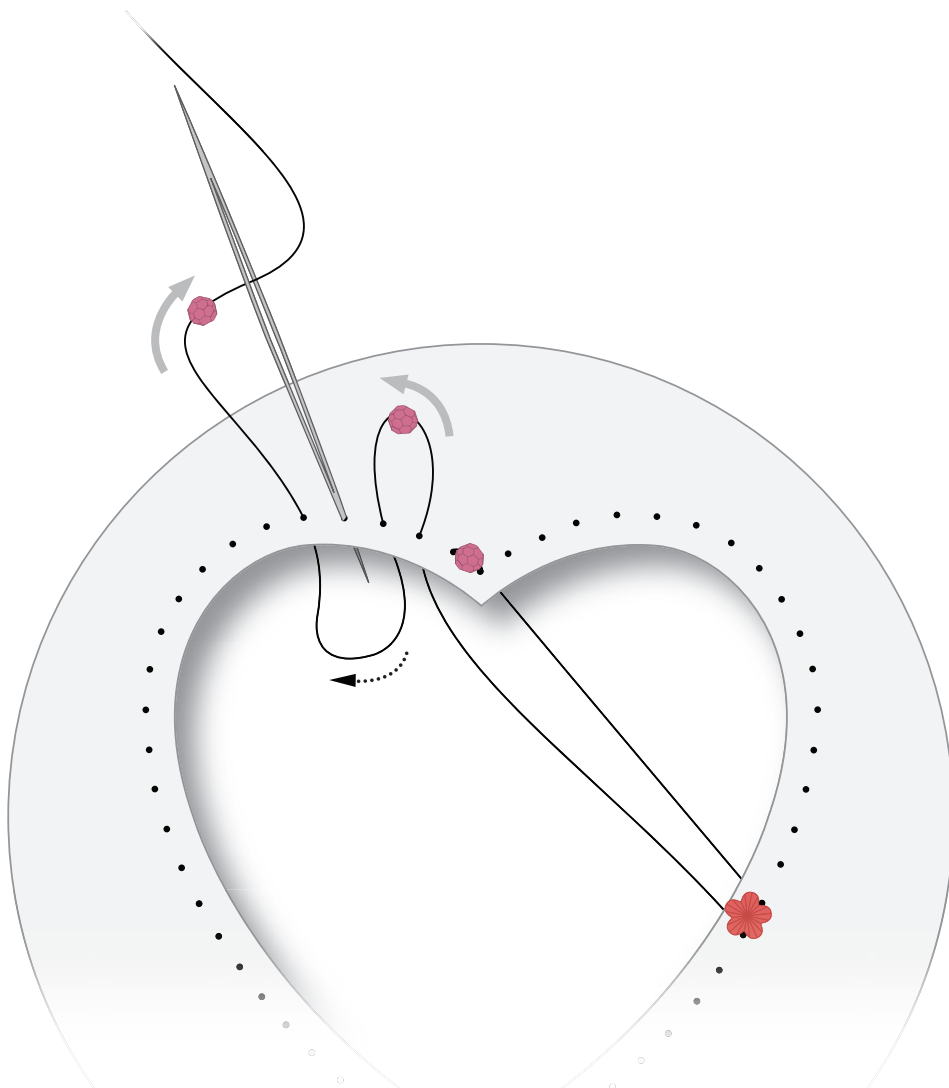

STEP 7

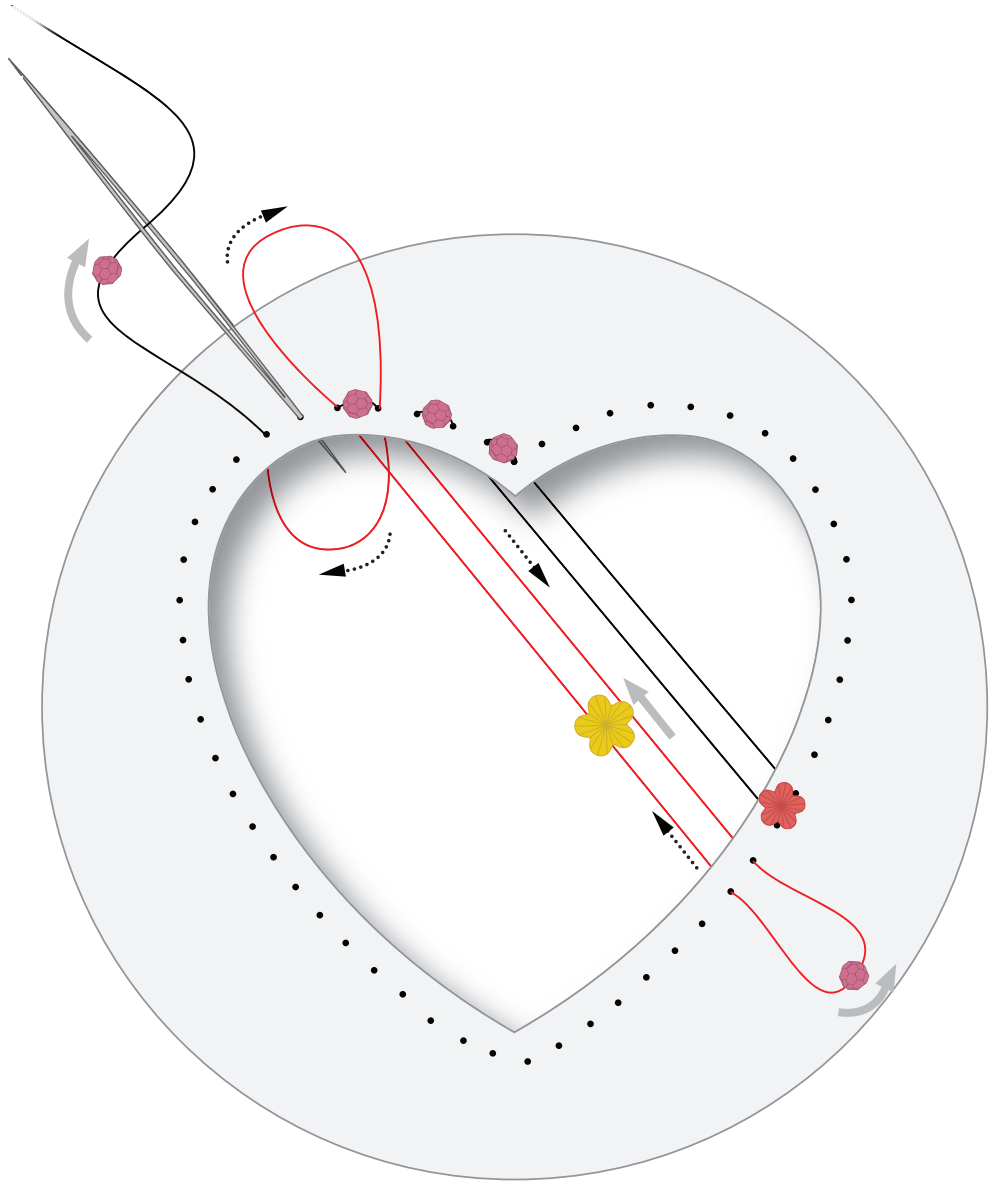

Repeat

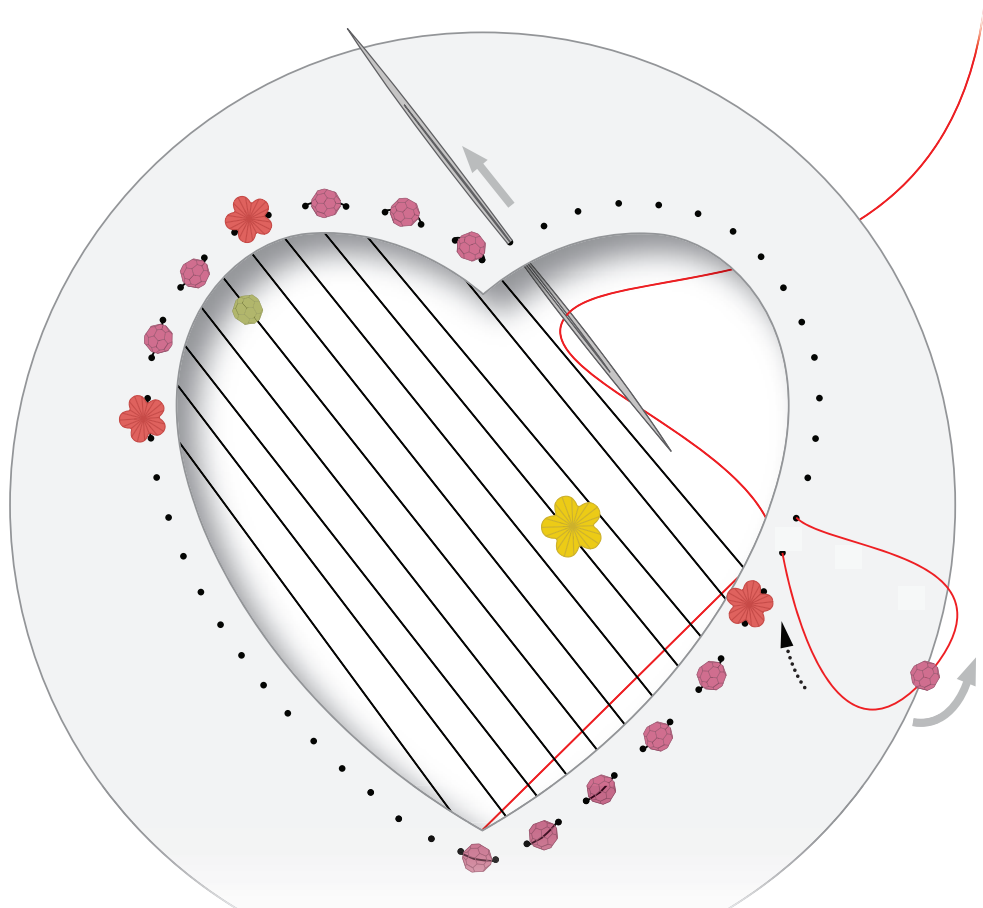

Repeat

STEP 8

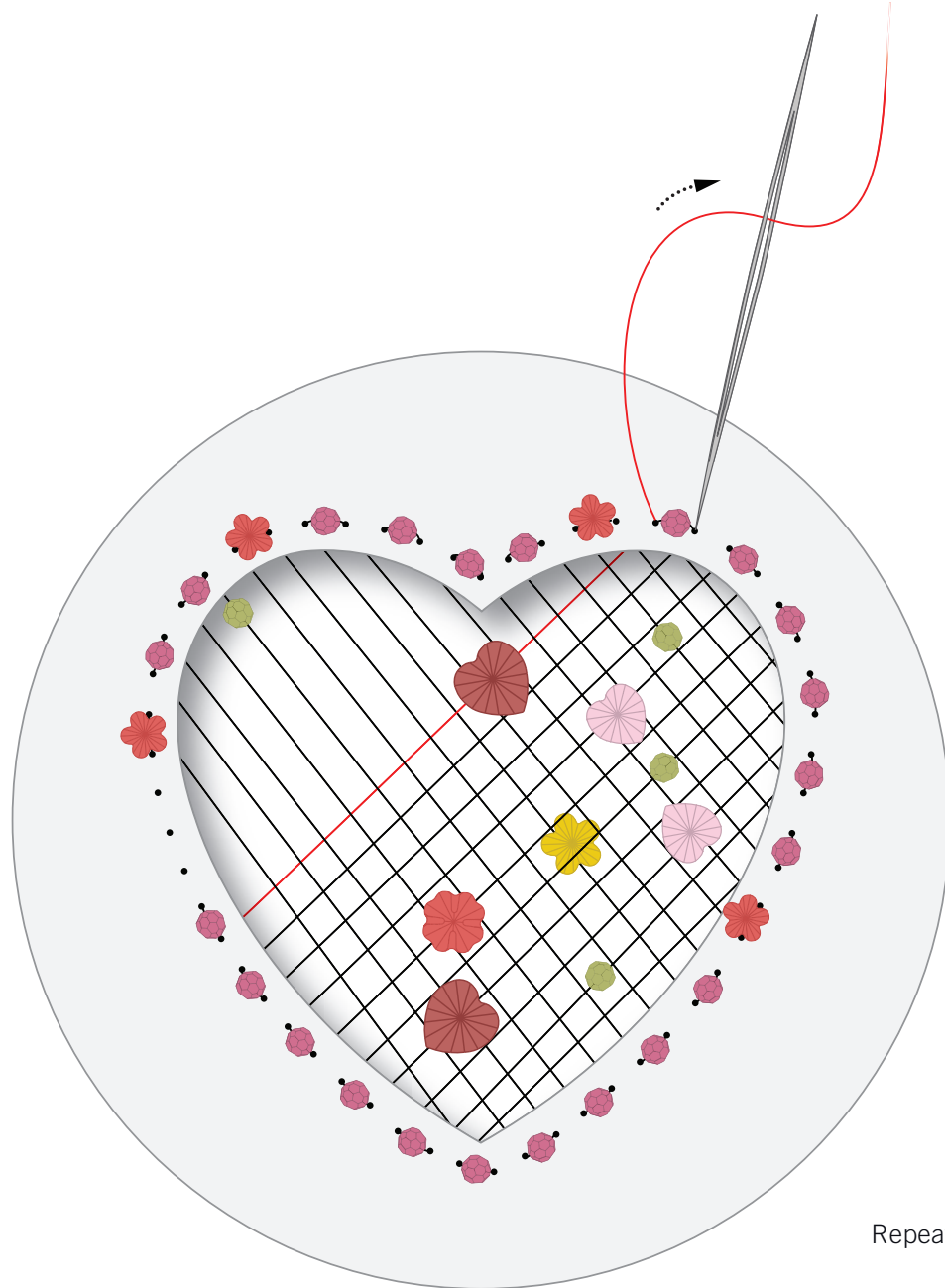

Repeat step 7

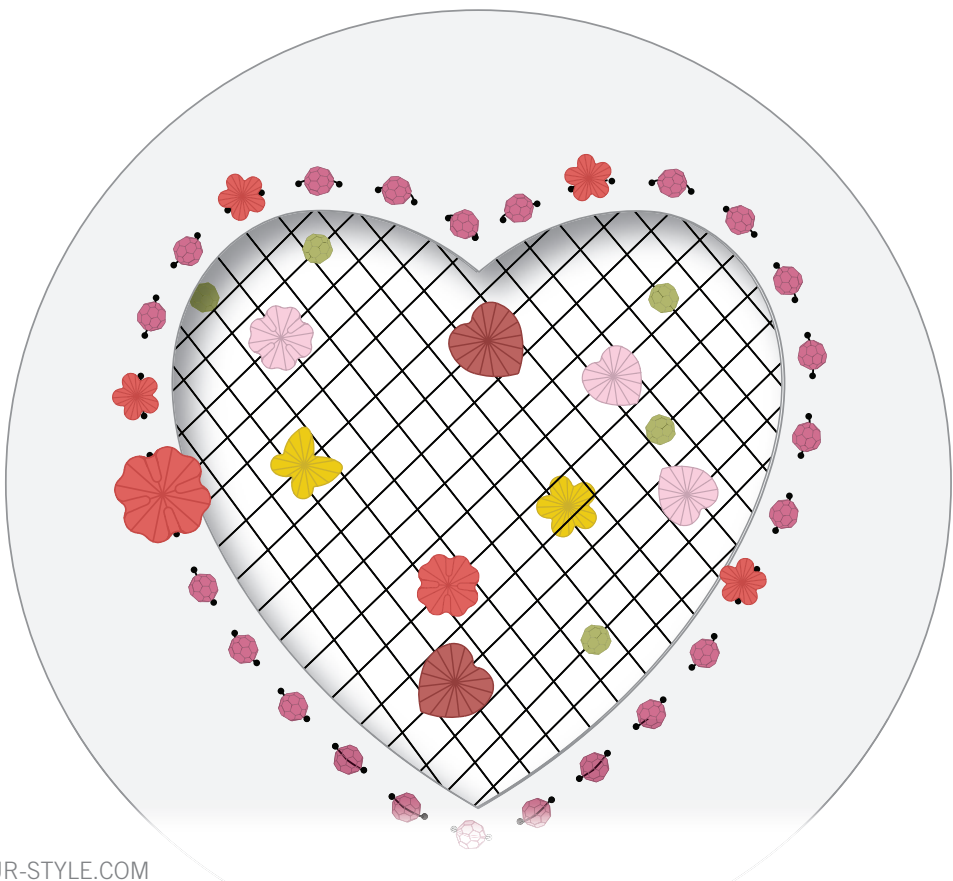

STEP 9

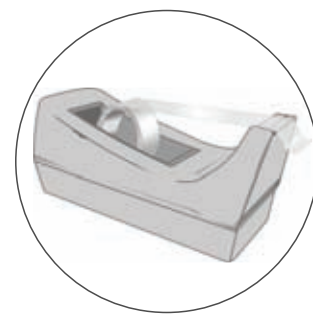
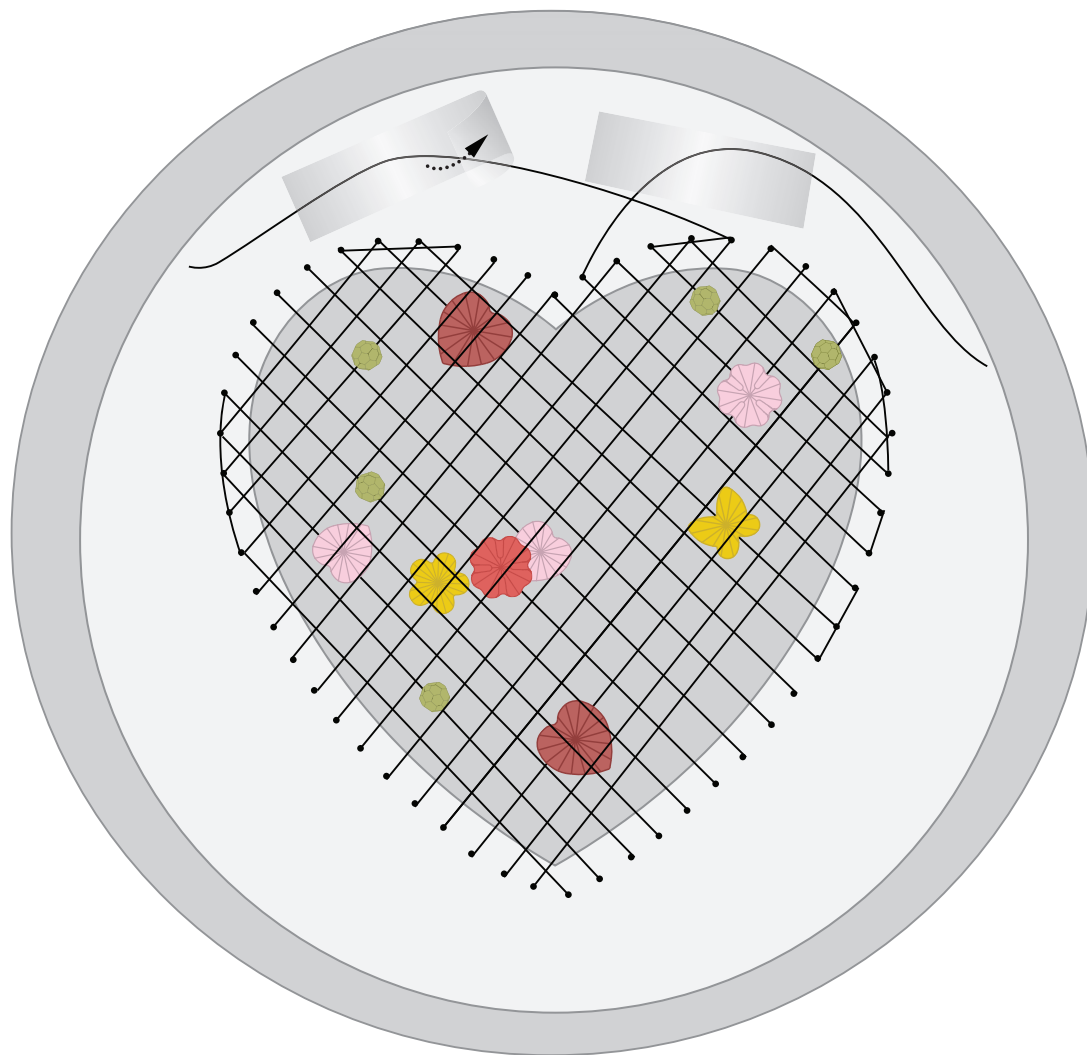

STEP 10

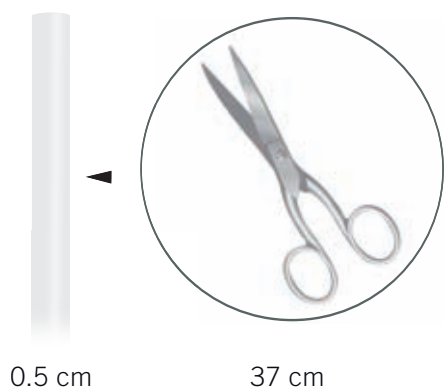

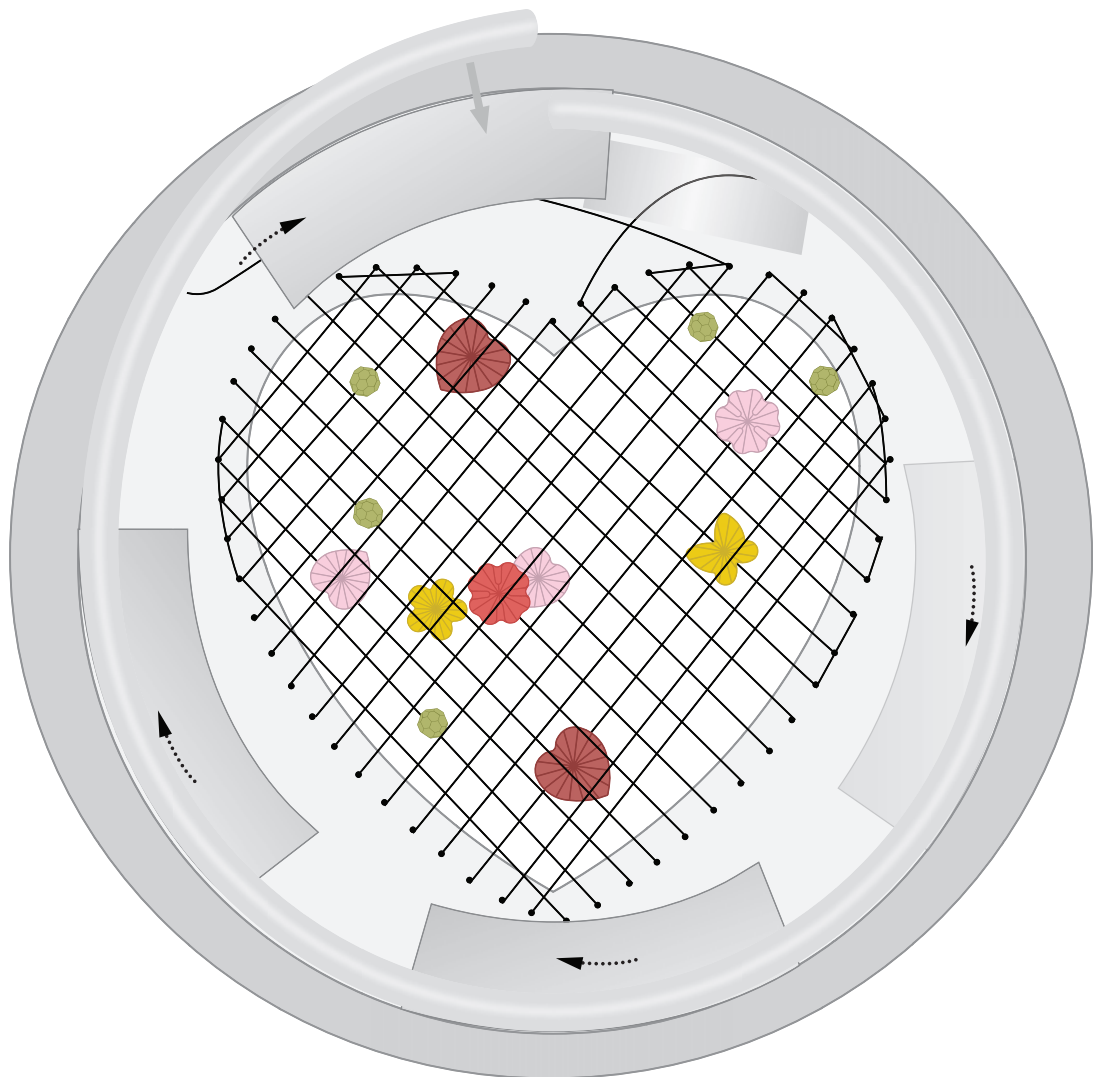
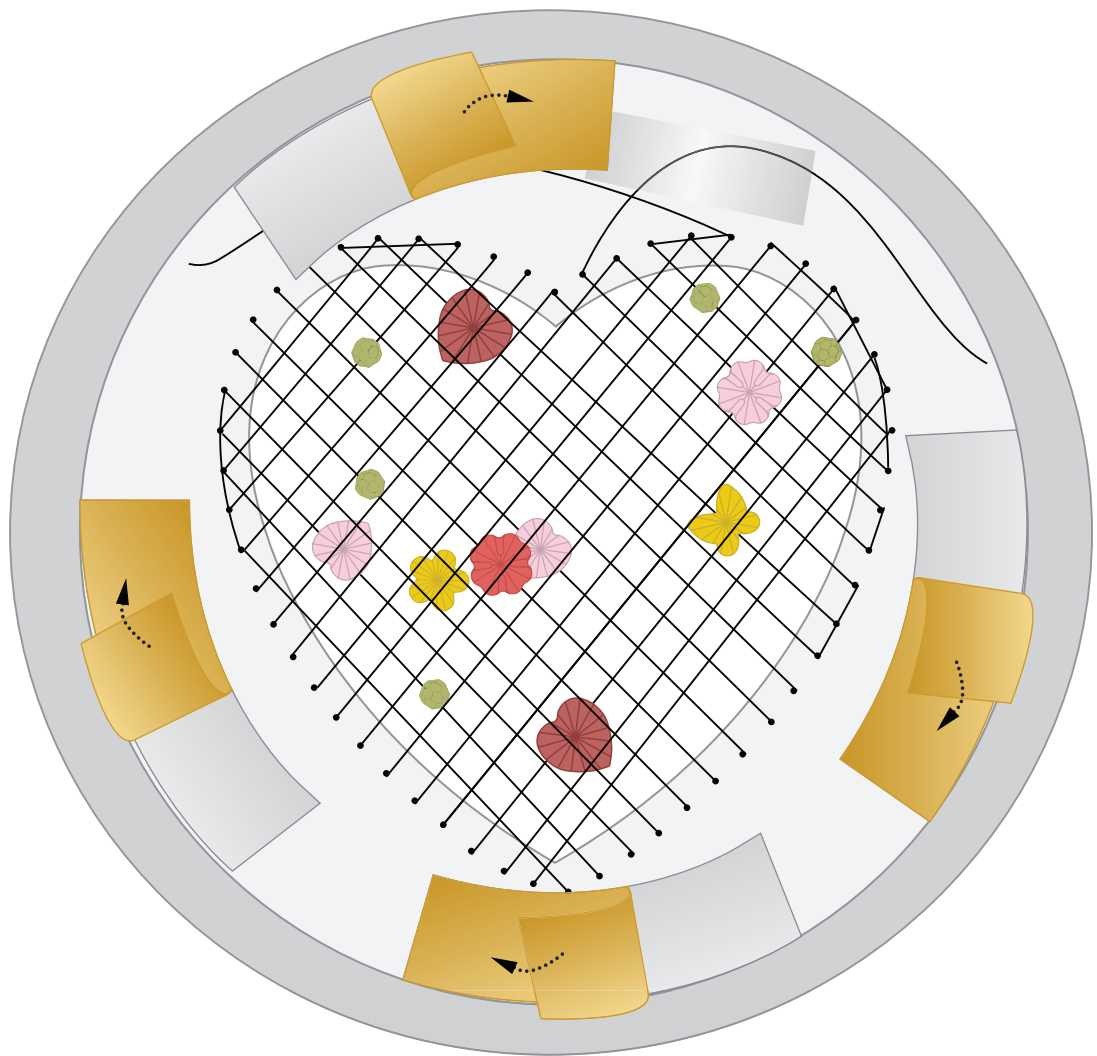

STEP 11

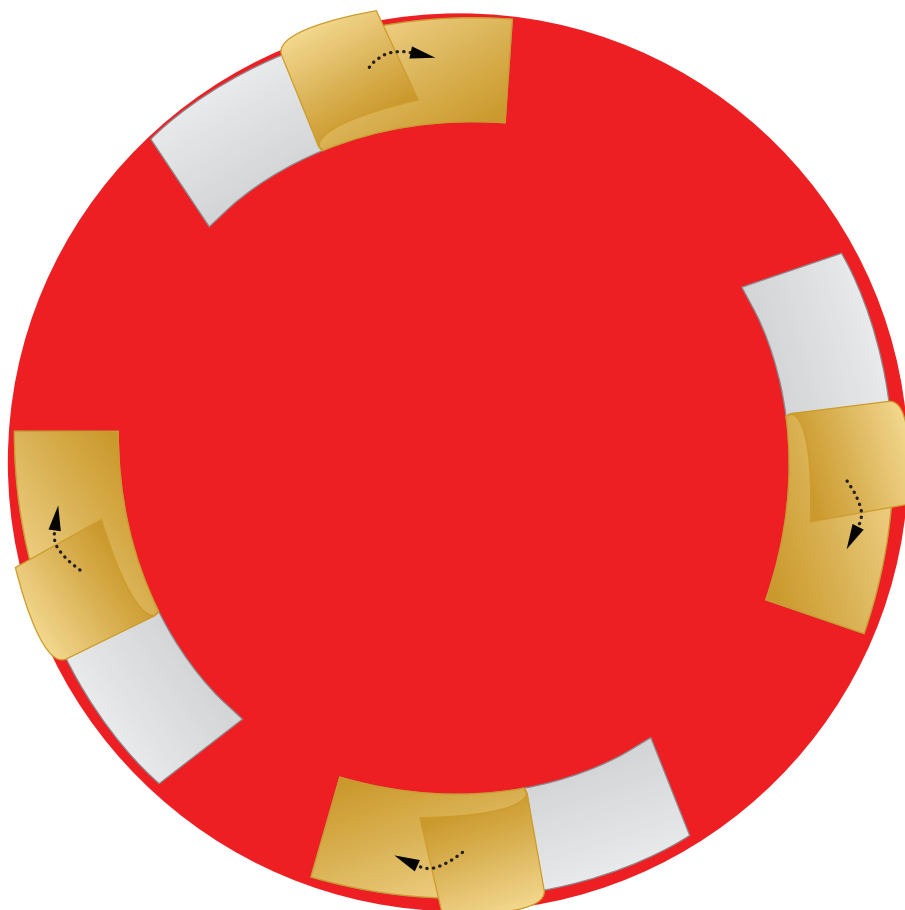
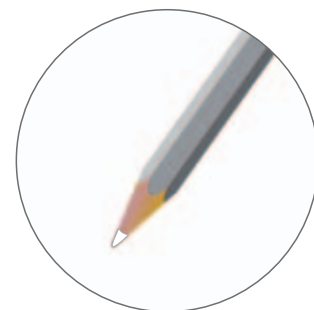
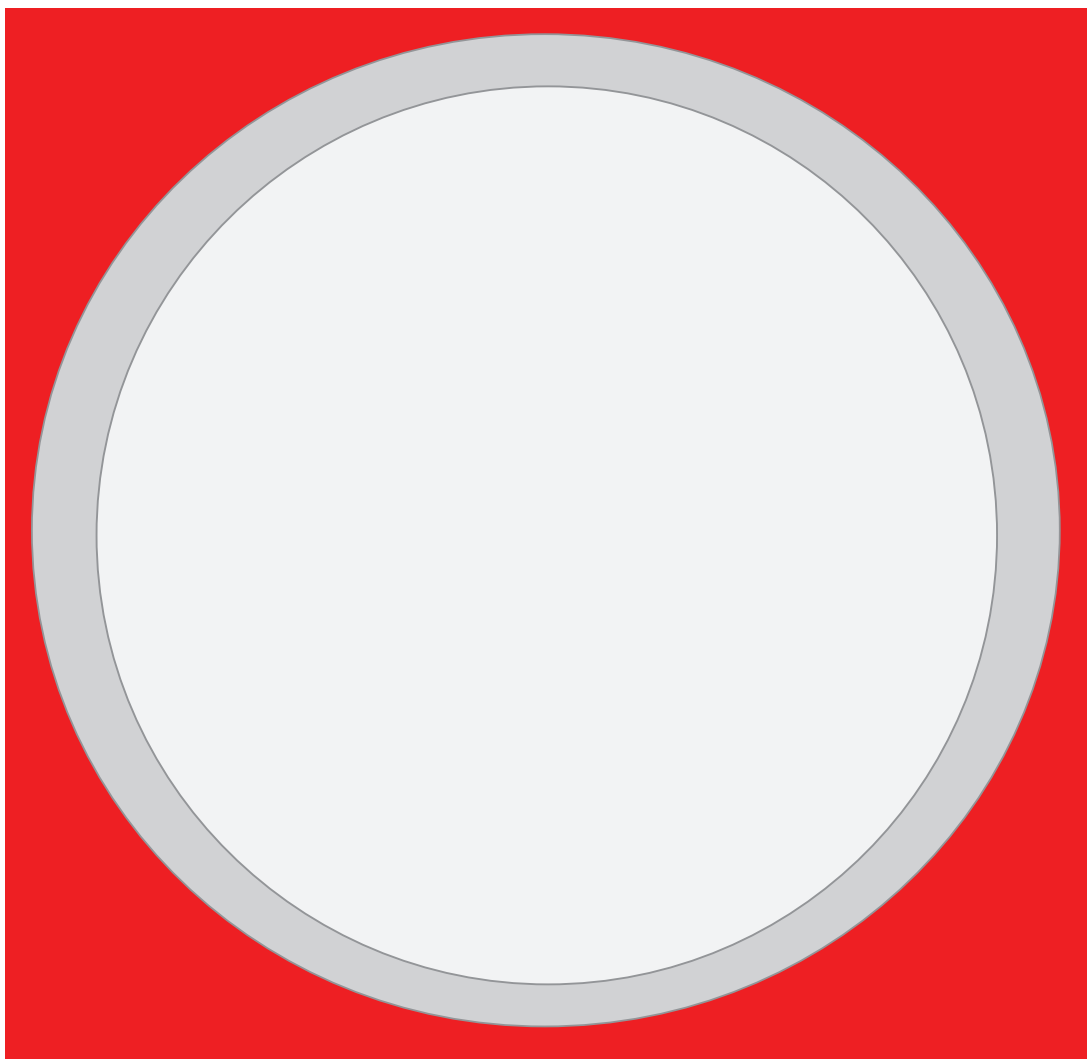

STEP 12

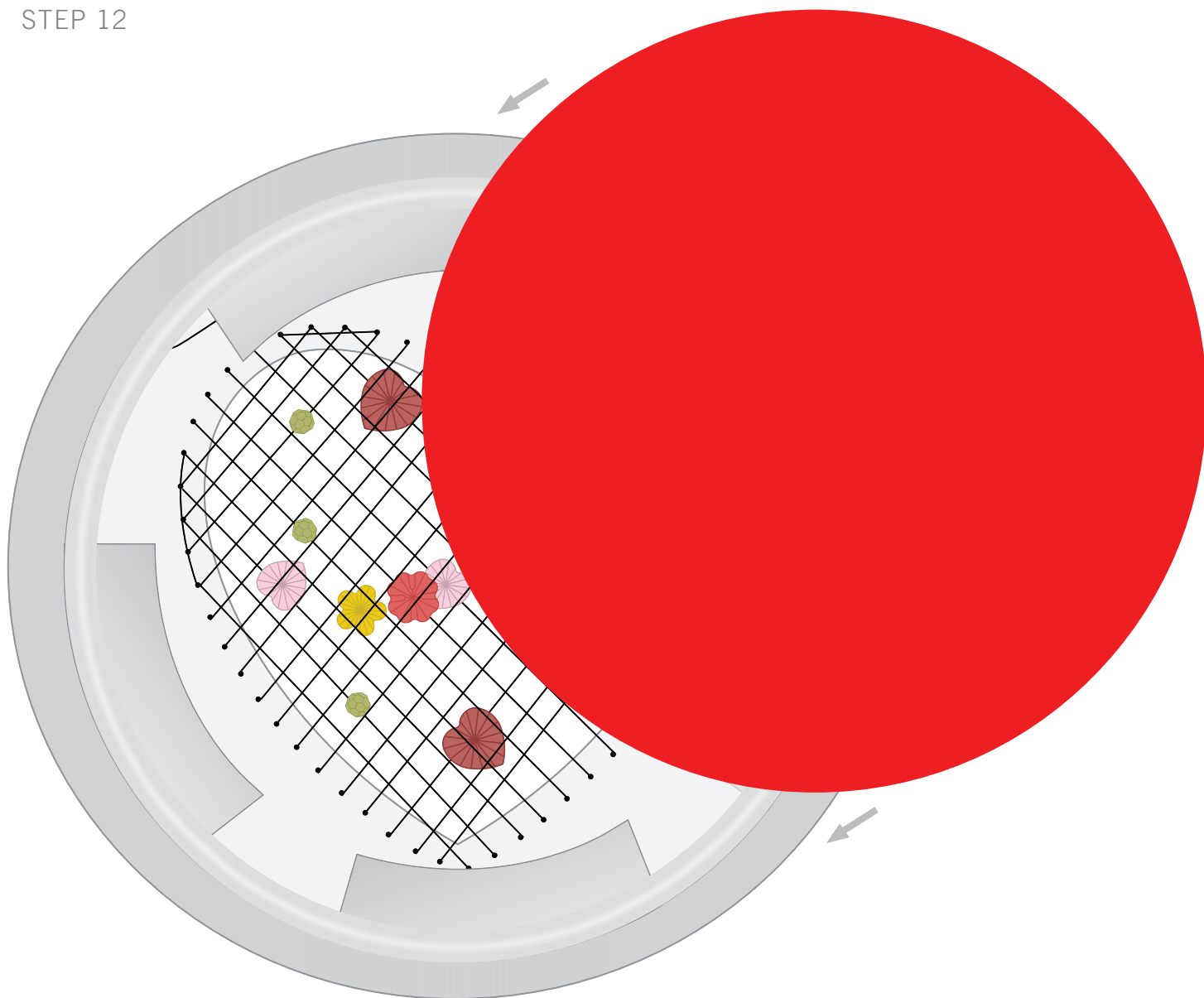

STEP 13

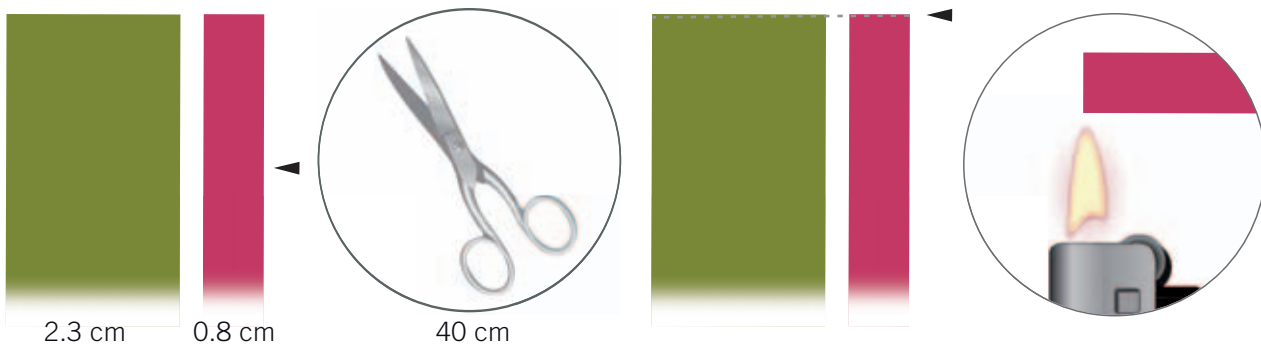

STEP 14

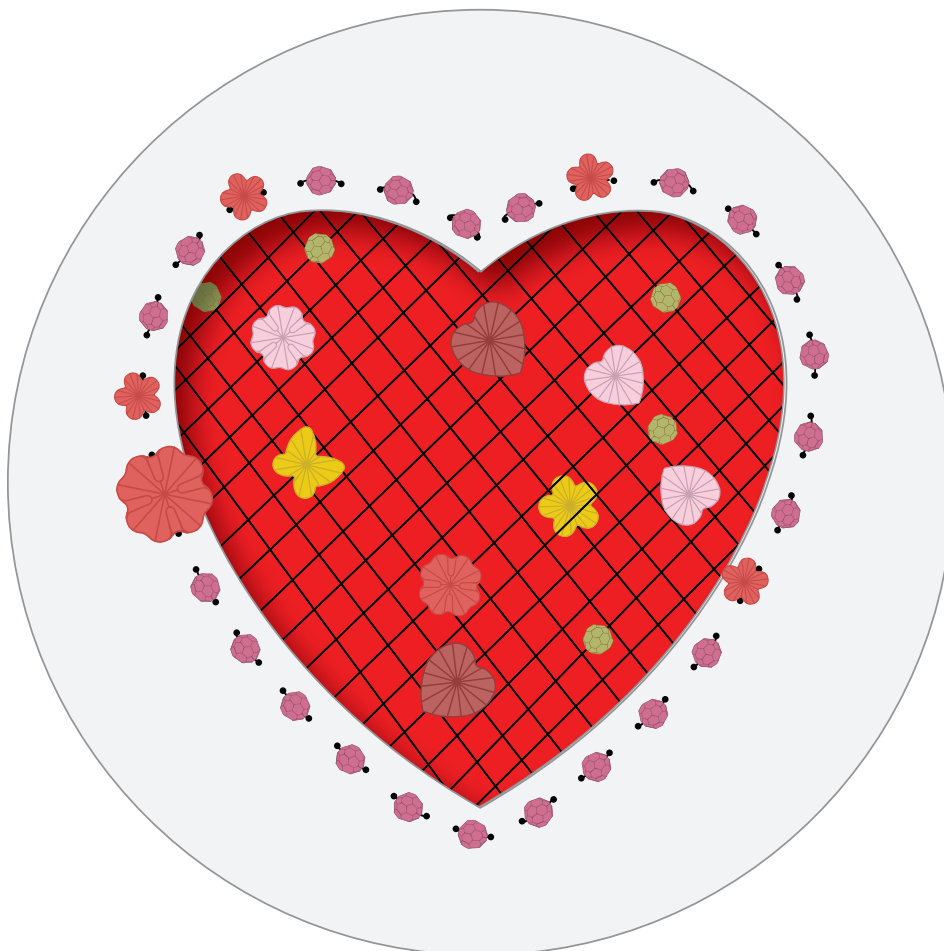
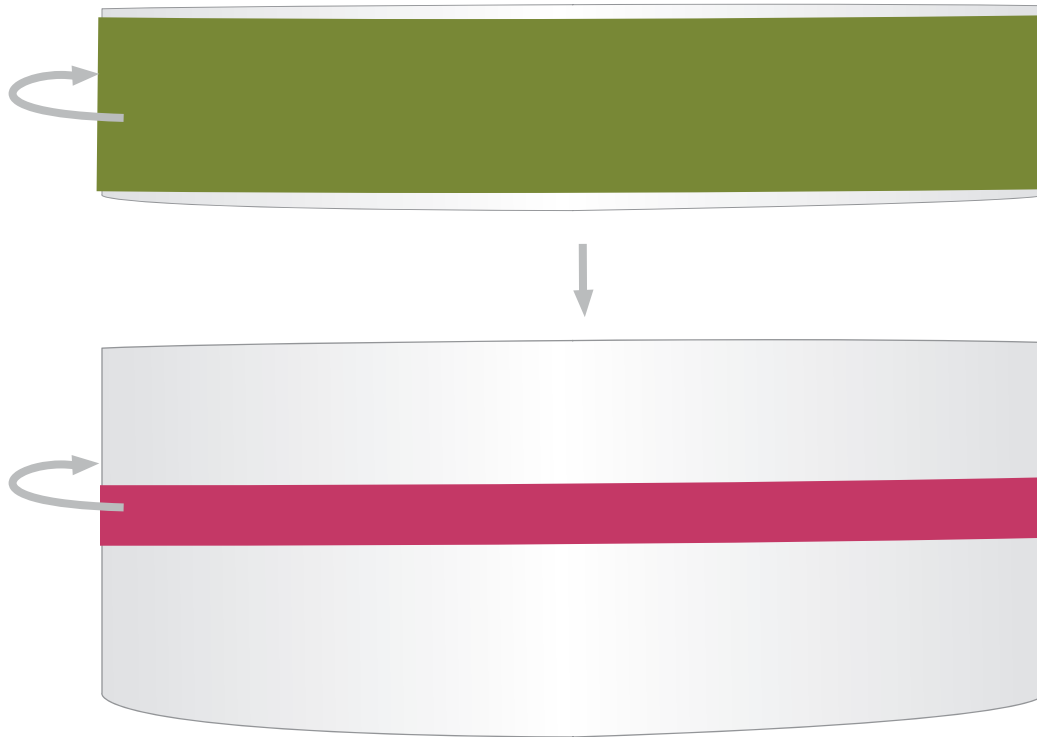

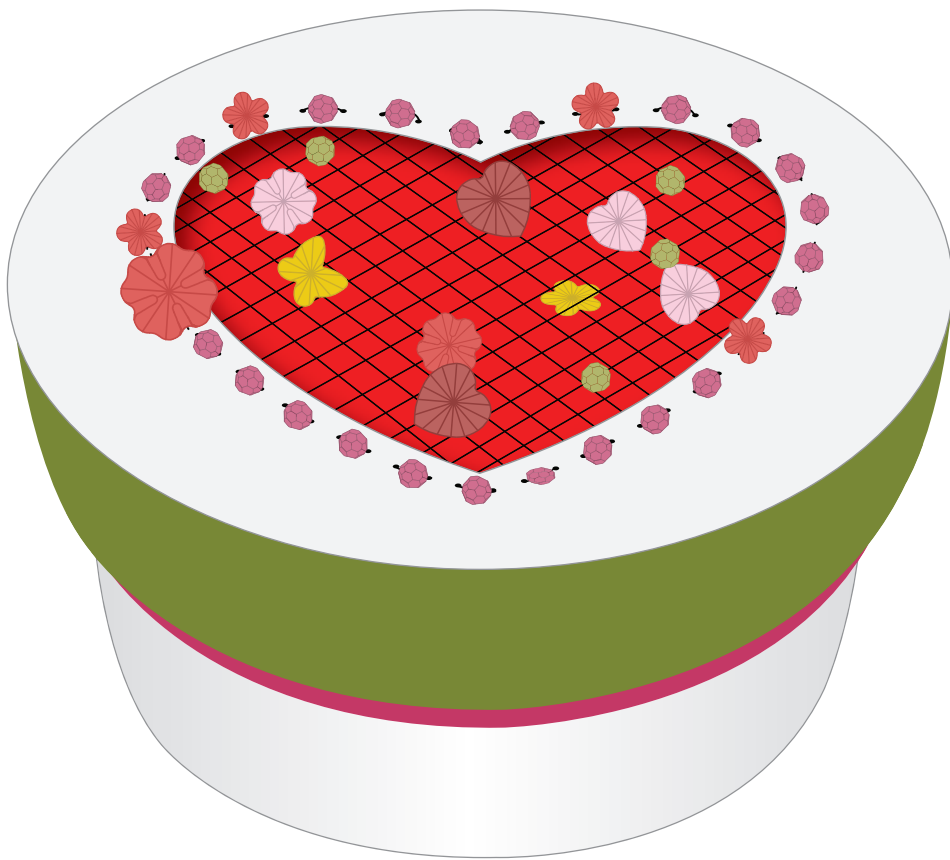

CREATE YOUR STYLE with SWAROVSKI ELEMENTS Design Project

Valentine's Day Gift Box "Heart"

- STEP 1: Print and cut out the pattern to measure 10x10cm.
- STEP 2: Apply double sided tape to the cardboard, adhere the pattern and cut the out heart.
- STEP 3: Place the stencil on top of the paper box, draw the outline of it on top of the paper box and cut it out using a cutter as shown in the illustration. Color in the cut out edge with a pencil.
- STEP 4: Place the pattern on top of the paper box and pierce through the marked points into the paper box and remove the pattern.
- STEP 5: Thread a beading needle with 1.5m of sewing silk. Pierce through one of the holes from the back side to the front as shown and insert a Swarovski Bead art. 5000 4mm Fuchsia. Affix the end of the thread on the back of the box with tape. Make a stitch through to the back of the box and then stitch the thread diagonally across the box. Insert a Swarovski Bead art. 5744 Light Siam and make a stitch through the next hole as depicted in the illustrations in this step.
- STEP 6: Continue sewing as shown adding Swarovski Beads as you go.
- STEP 7: Once you reach the end cross over to the other holes in the paper box as shown in the last illustration.
- STEP 8: Follow the process as shown in step 7 to complete the structure shown in the last illustration of this step.
- STEP 9: Affix the thread end on the back of the paper box as shown.
- STEP 10: Cut 37cm of 0.5cm thick rubber tube. Affix it around the inner portion of the lid using double sided tape.
- STEP 11: Using the other part of the lid trace out the diameter onto a piece of red cardboard, cut it out and apply double sided tap to it.
- STEP 12: Affix the red cardboard onto the rubber tube.
- STEP 13: Cut 40cm of green colored velvet ribbon and fuchsia colored satin ribbon. Burn the ends with a lighter and apply double sided tape to both.
- STEP 14: Stick both ribbons onto the paper box lids and affix as depicted in the illustration in this step.