

CREATE  
YOUR STYLE with  
CRYSTALLIZED™  
-Swarovski Elements

DESIGN PROJECT  
SUMMER HOLIDAYS  
BAG



# SUMMER HOLIDAYS BAG

## CRYSTALLIZED™ – Swarovski Elements

Article	Product Group	Article No.	Amount	Size	Colour	Colour Code
	Beads	5000	6 pcs.	14 mm	Crystal	001
	Crystal Pearls	5811	8 pcs.	12 mm	Crystal Light Grey Pearl	001 616
	Crystal Pearls	5811	6 pcs.	12 mm	Crystal Platinum Pearl	001 459
	Crystal Pearls	5811	2 pcs.	14 mm	Crystal Light Grey Pearl	001 616
	Crystal Pearls	5811	6 pcs.	14 mm	Crystal Platinum Pearl	001 459
	Pendants	6039	2 pcs.	38 mm	Crystal Silver Shade	001 SSHA

## Supplies & Tools

- Supplies**
- Button hole silk, grey, 5 m
  - Linen cotton, 140 cm, white, 40 cm
  - Ribbon cotton, 1.5 cm, grey, 1 spool
  - Sewing silk, white, 1 spool
- Tools**
- Flat iron
  - Measuring tape
  - Needle
  - Pins
  - Scissors
  - Sewing machine

Level of design: **ADVANCED**

Have also a look at the **text instruction** at the last page!

### STEP 1

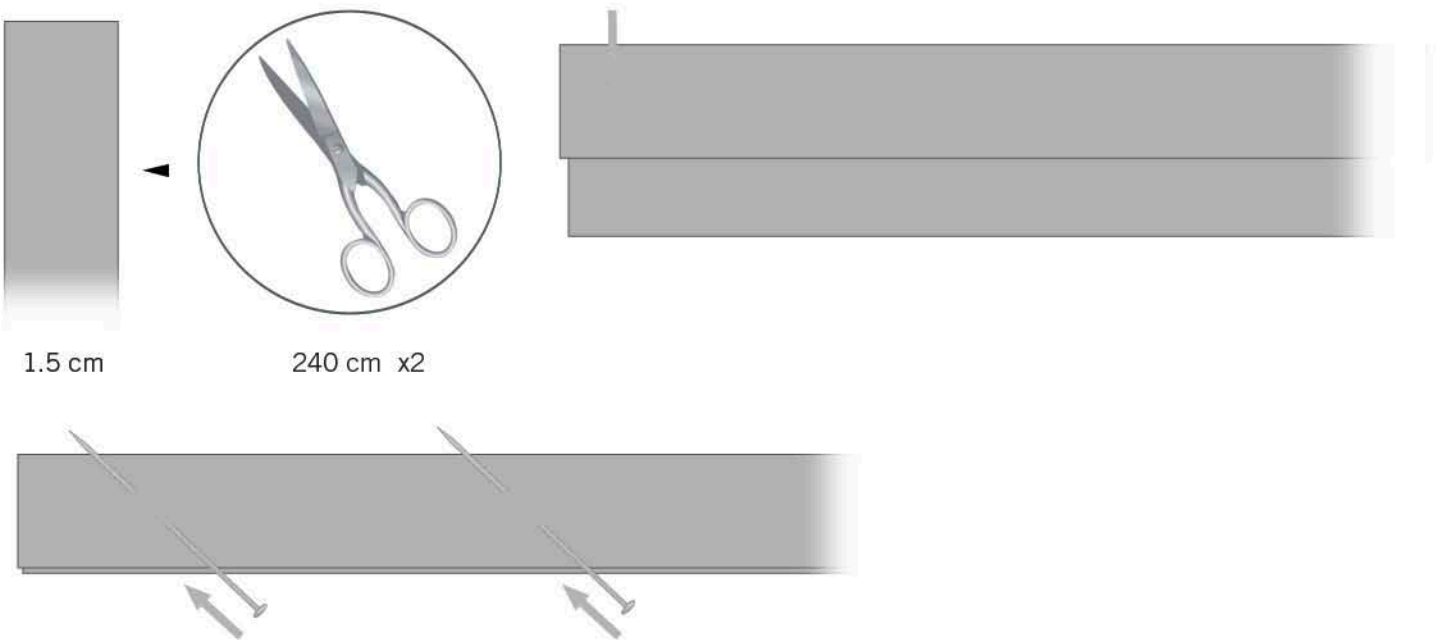

STEP 2

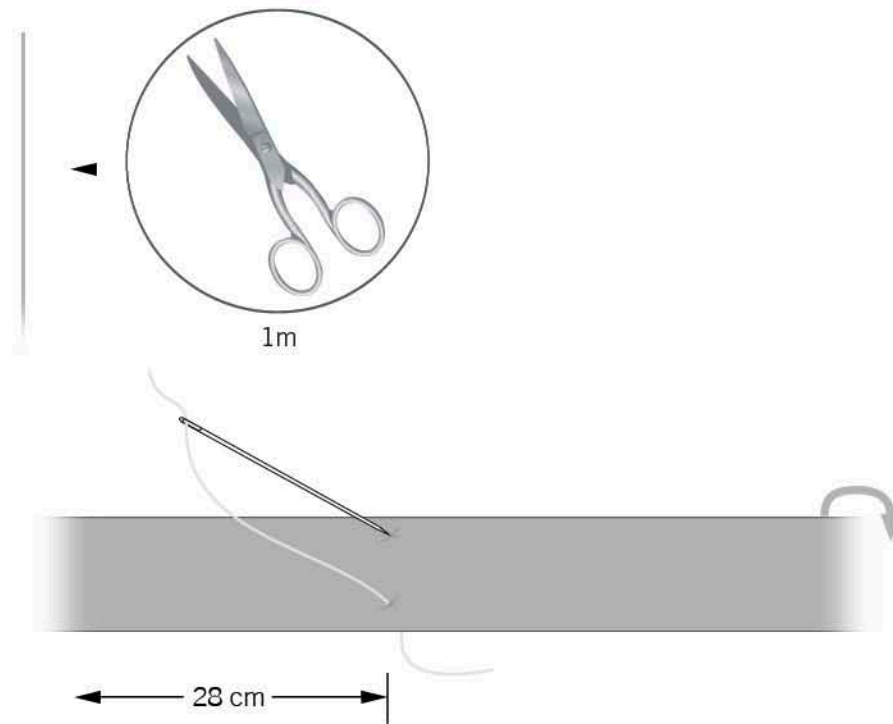

STEP 3

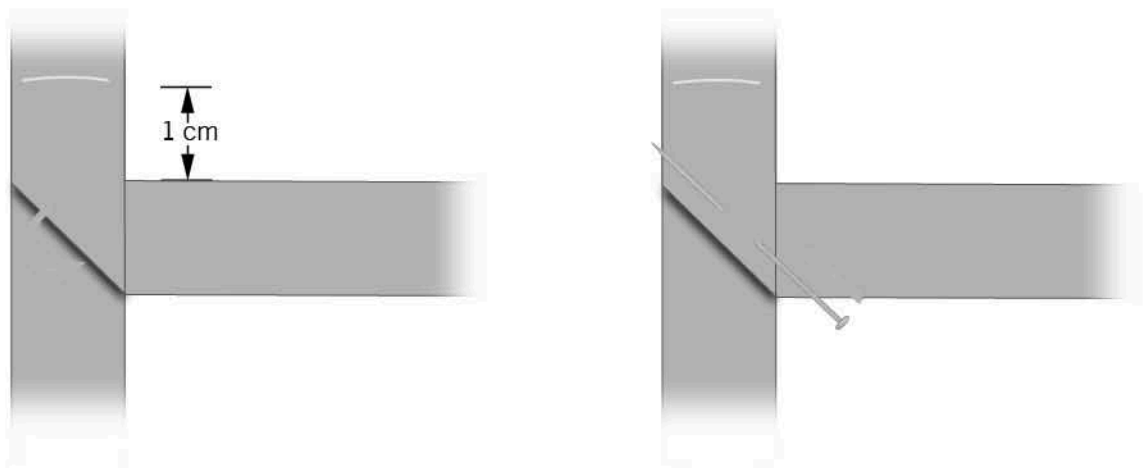

STEP 4

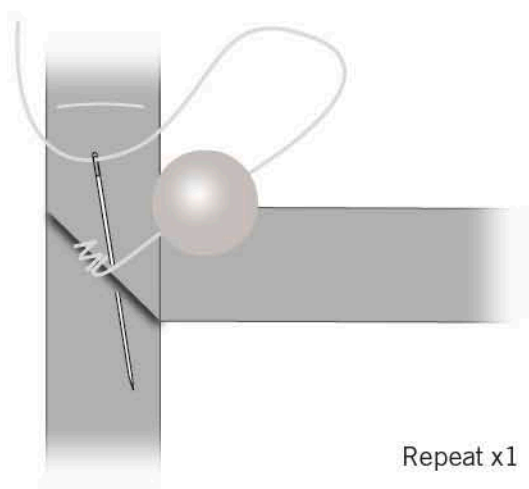
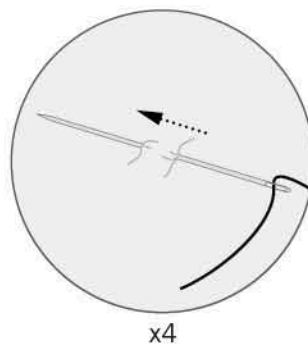
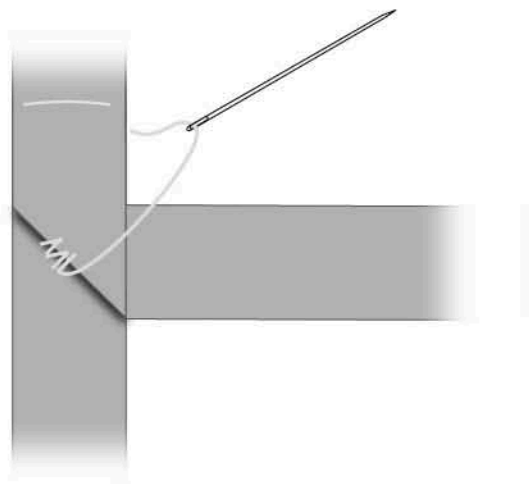

Repeat x1

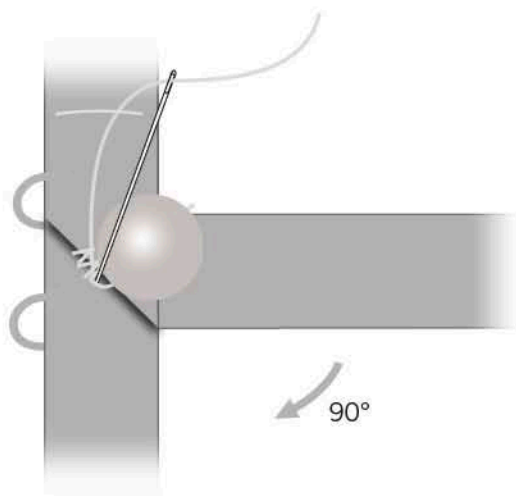

90°

STEP 5

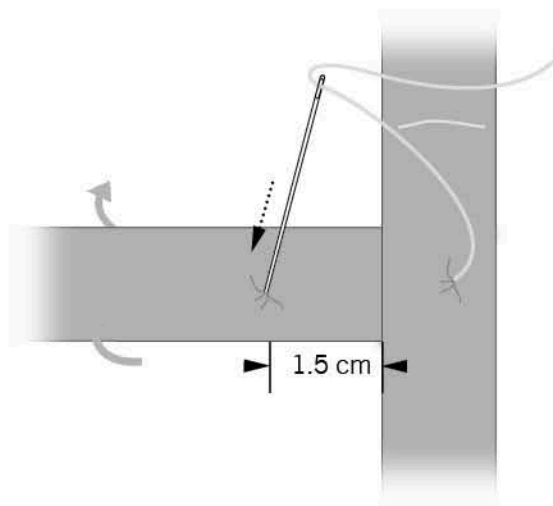
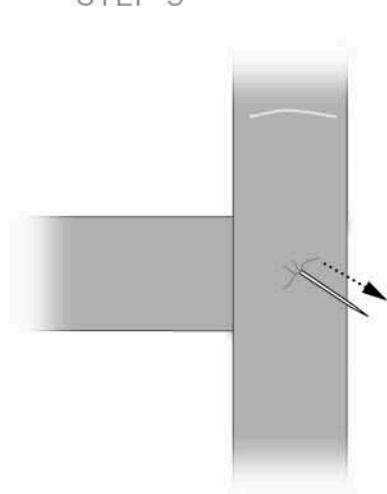

1.5 cm

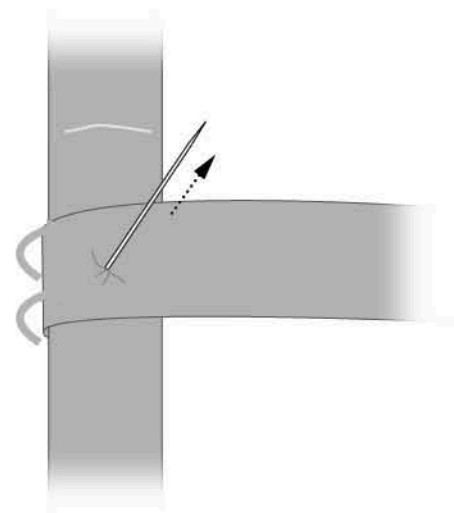

STEP 6

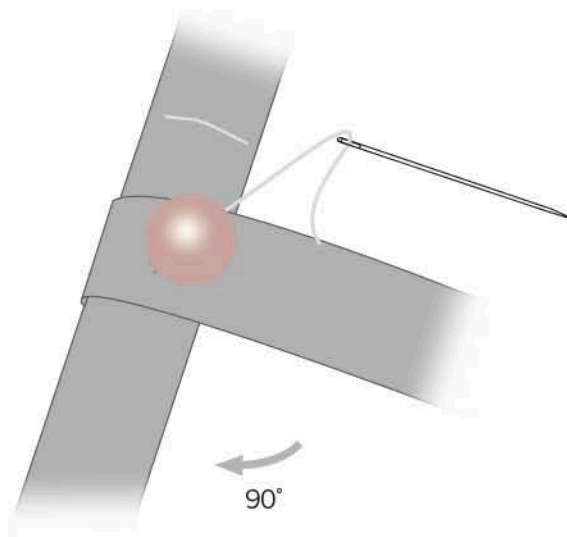
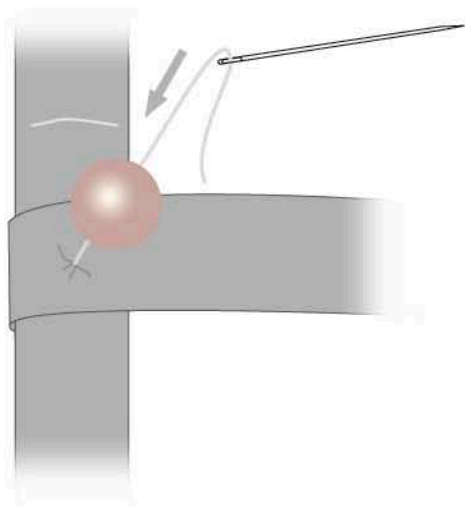

STEP 7

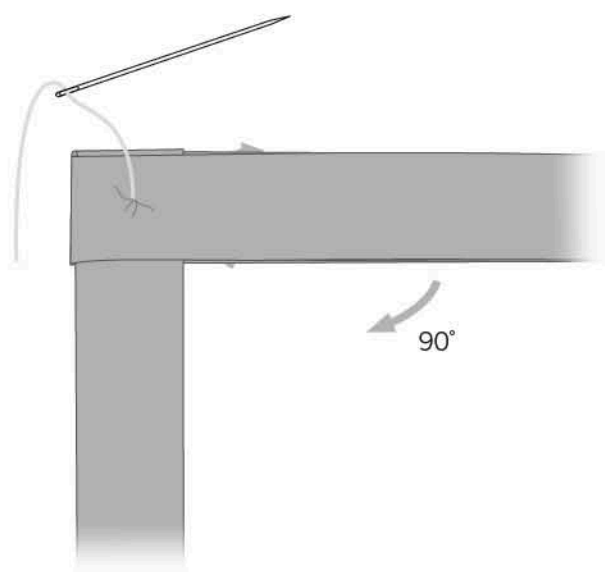
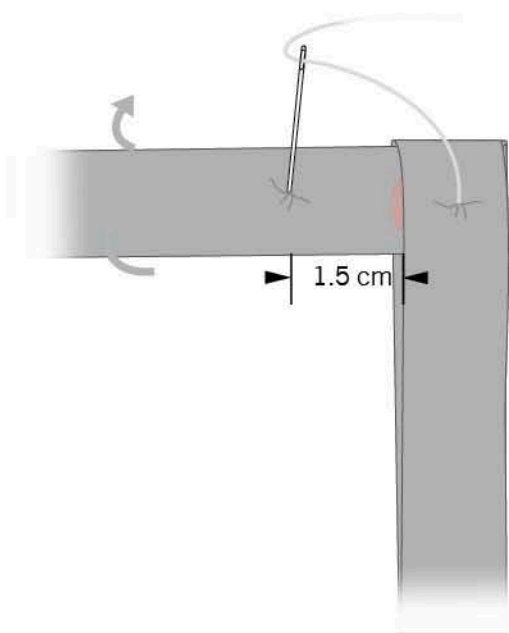
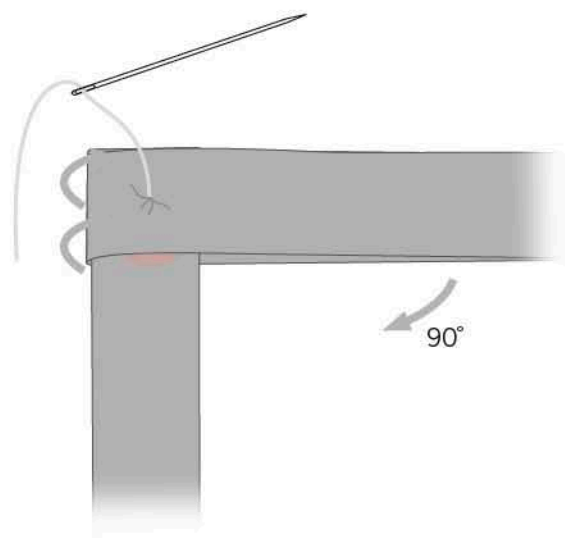
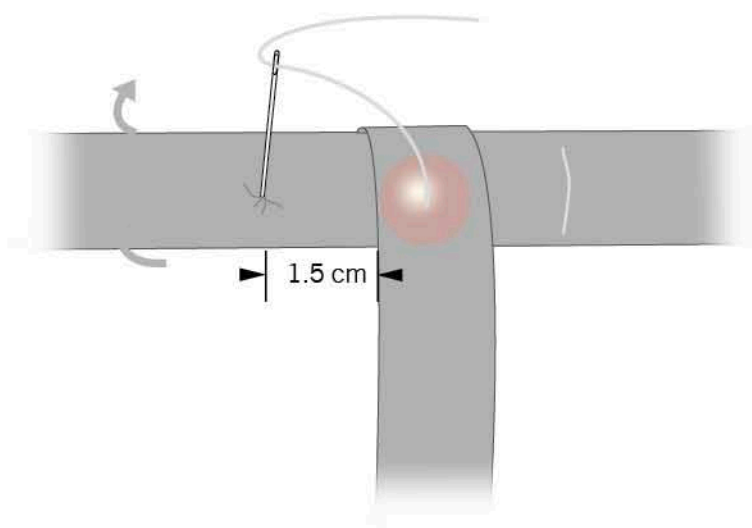

Repeat steps 5-7 x12

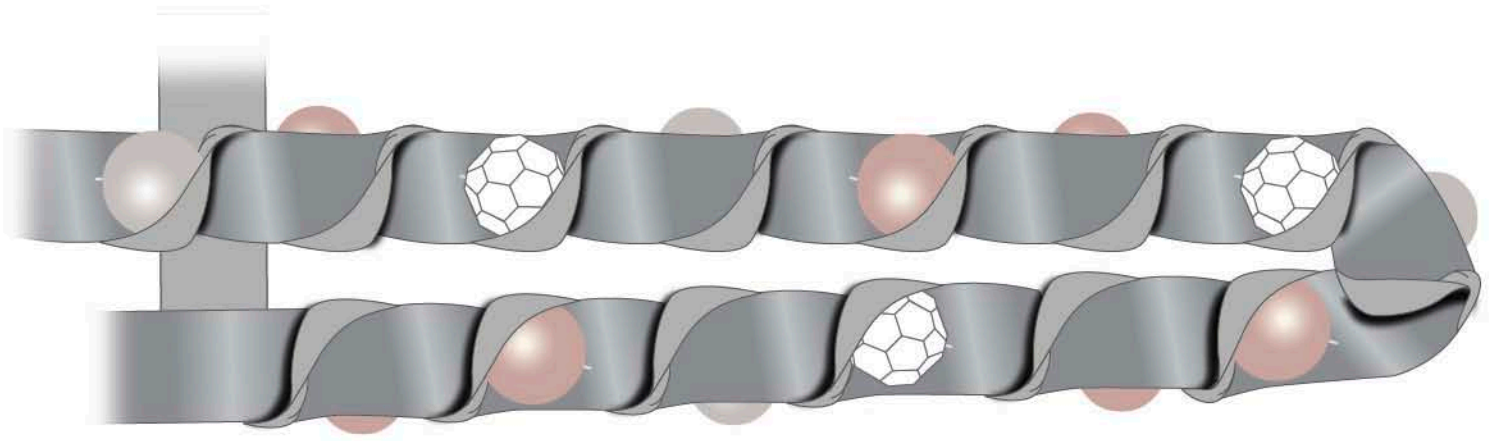

STEP 8

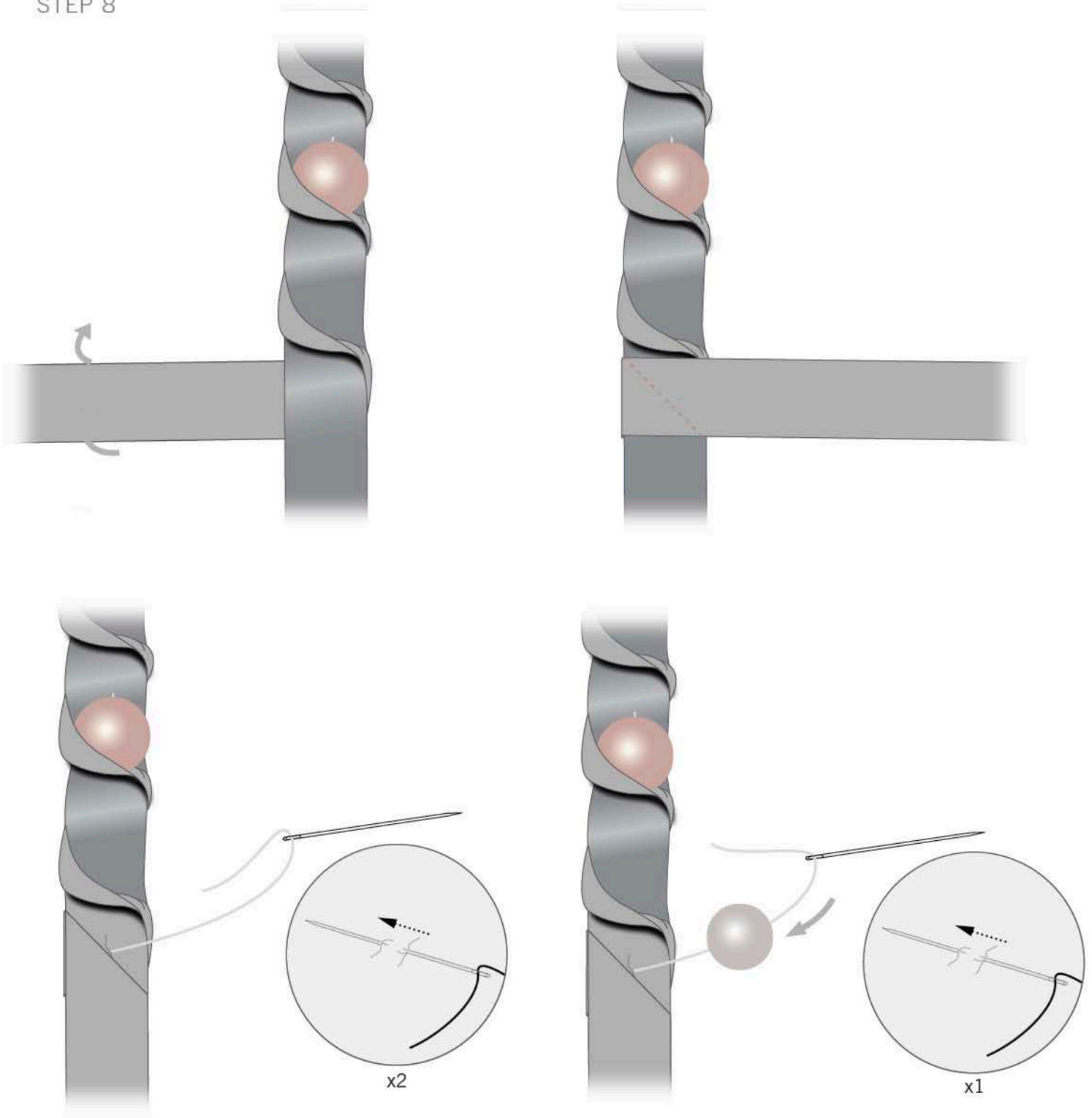

STEP 9

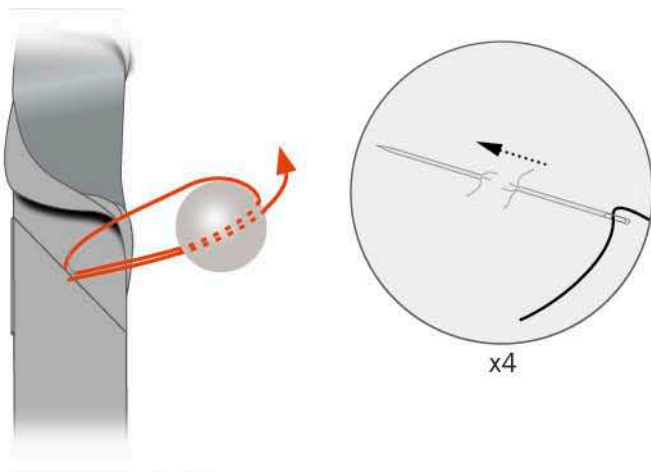

STEP 10

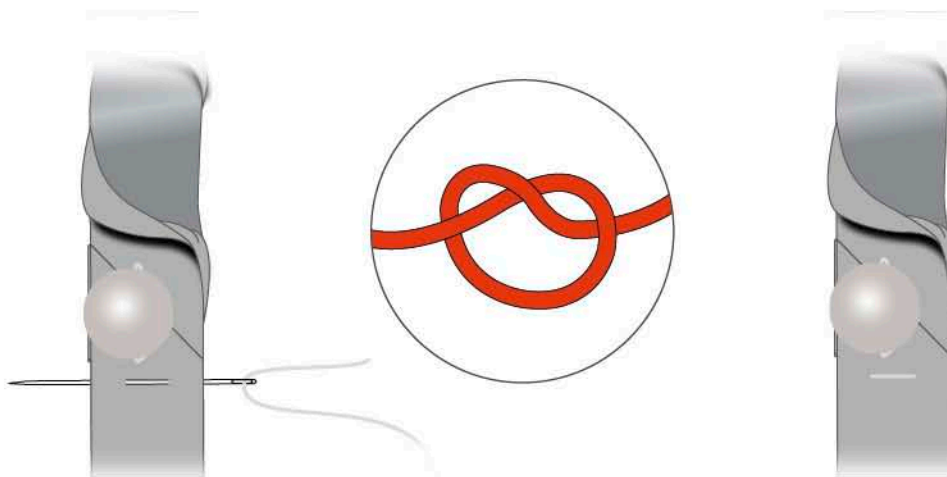

STEP 11

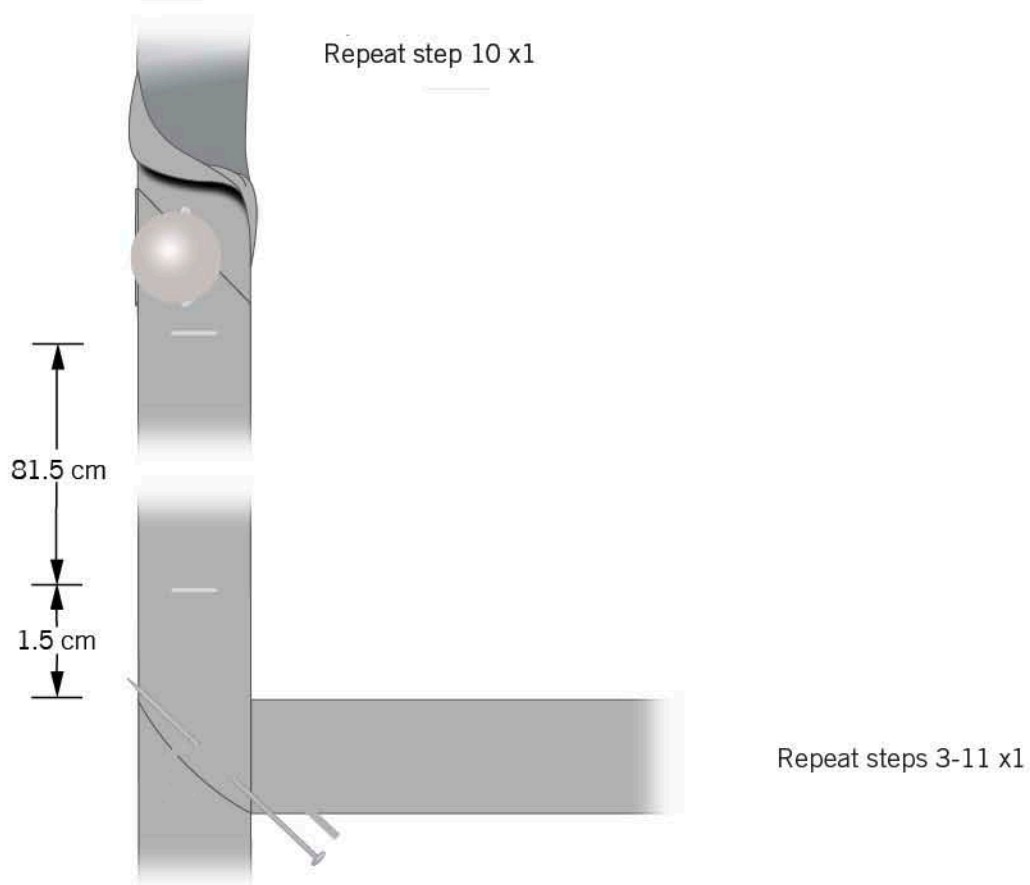

STEP 12

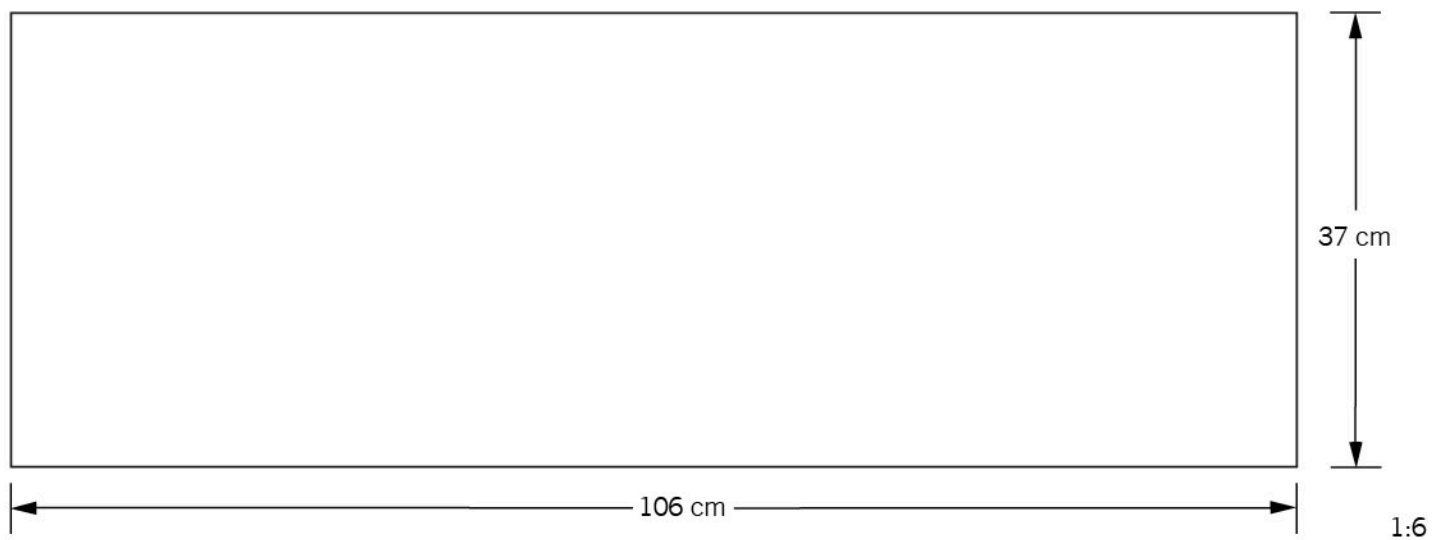

STEP 13

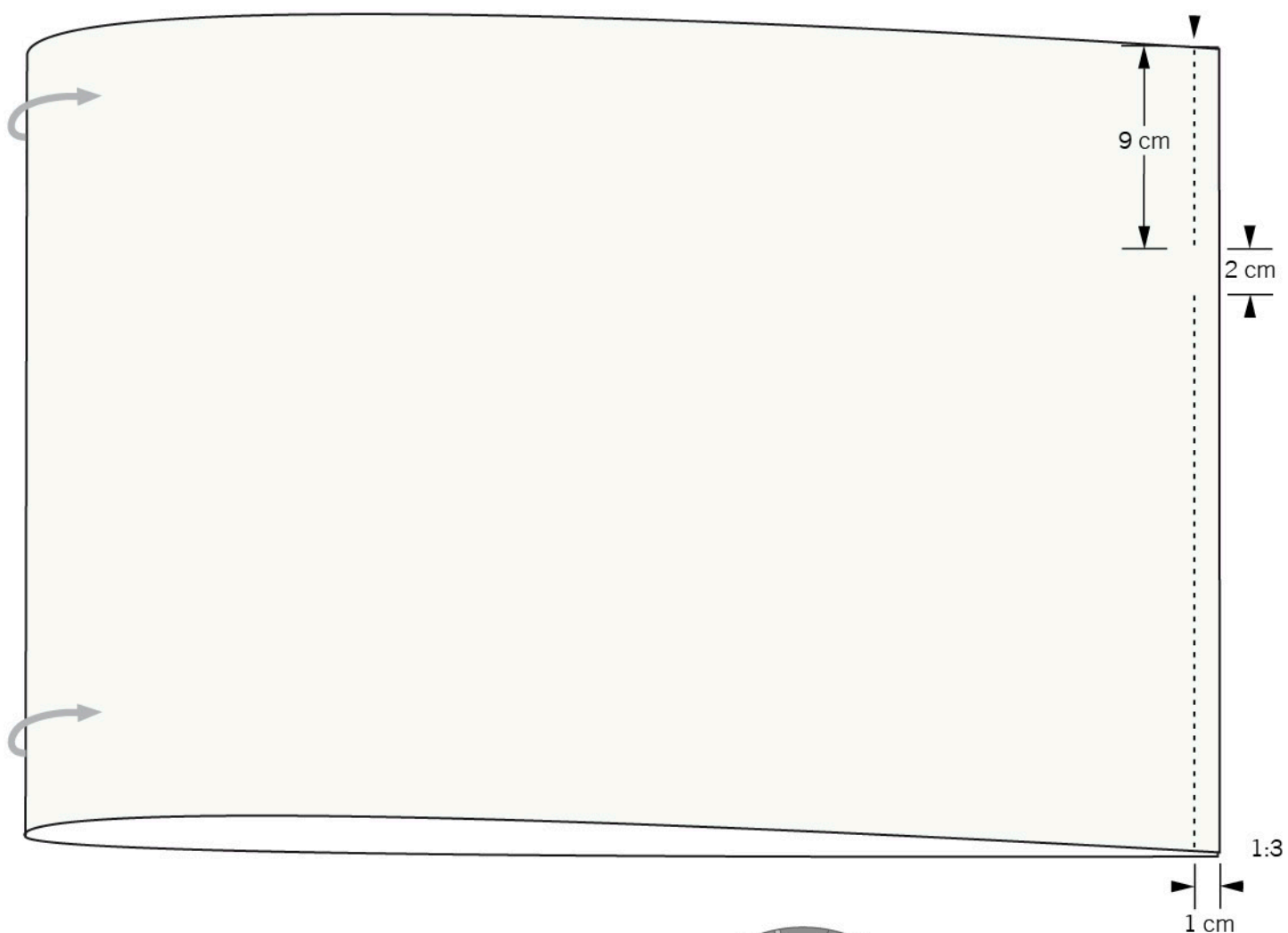



STEP 14

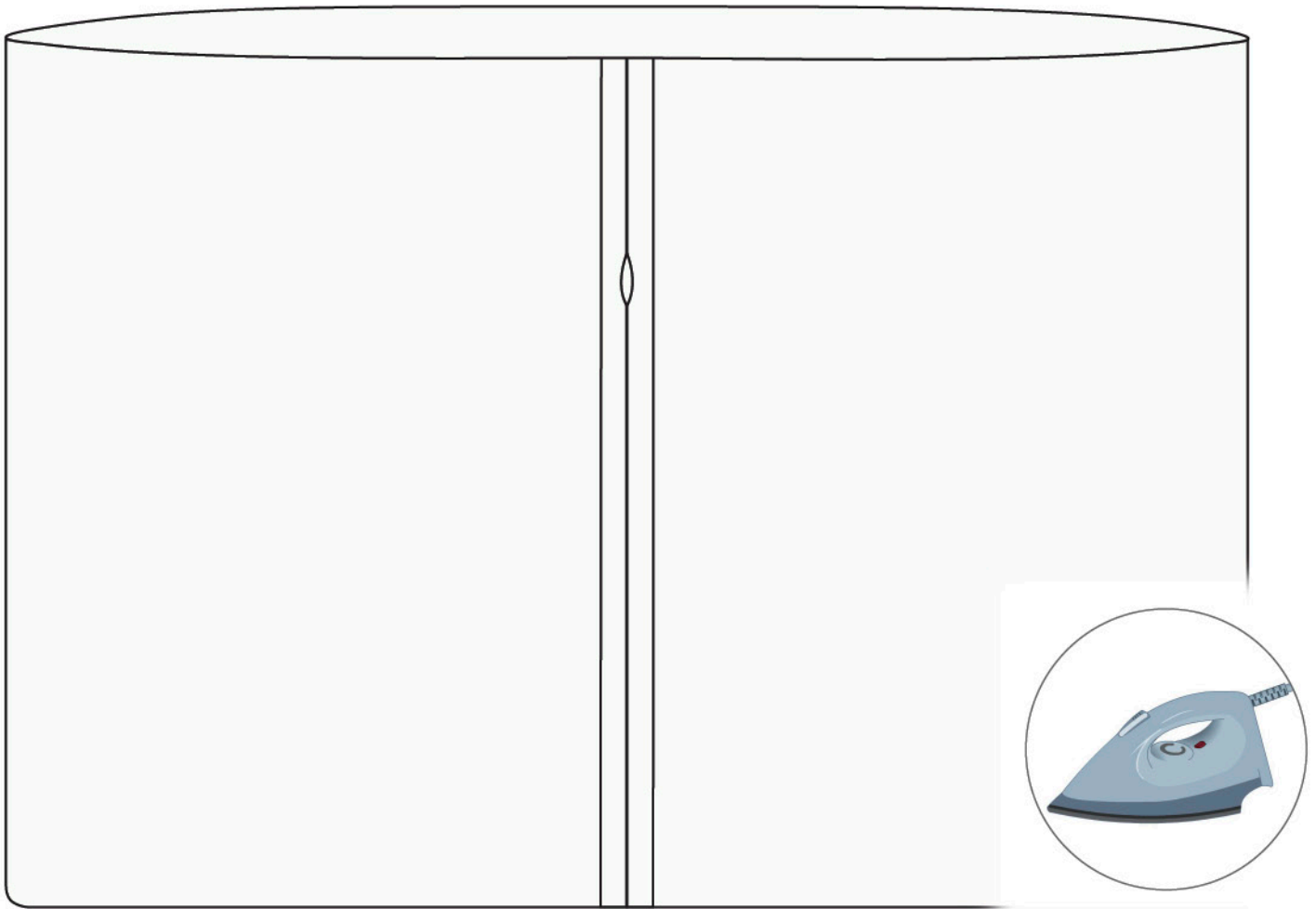

STEP 15

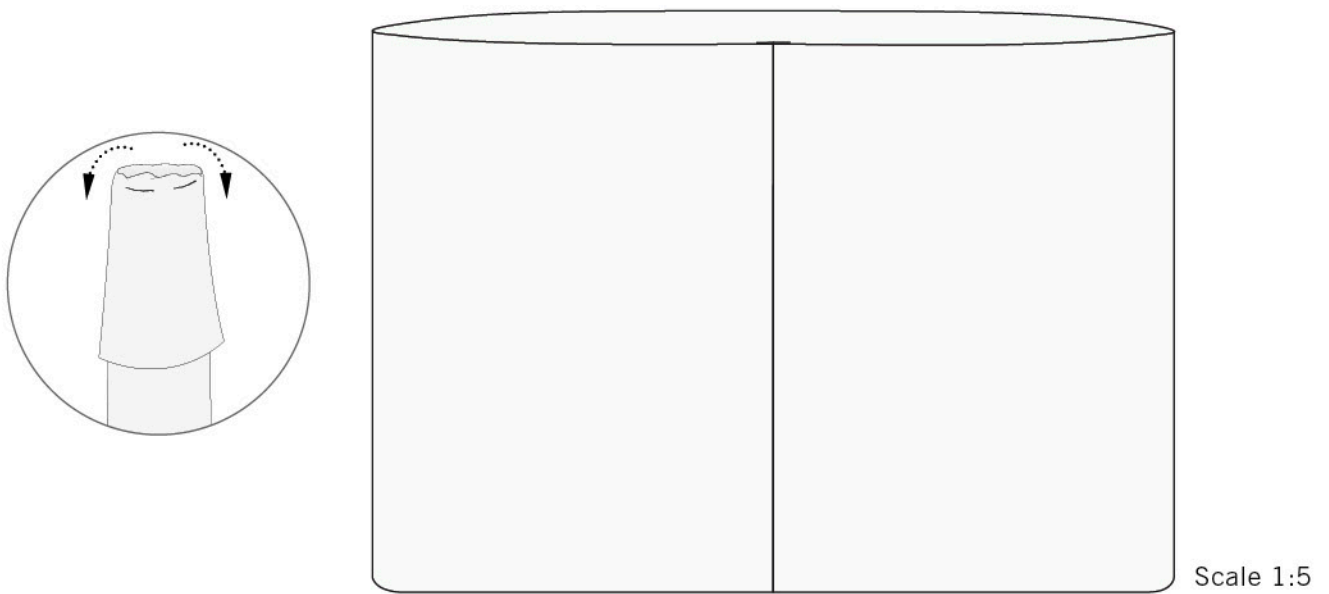

STEP 16

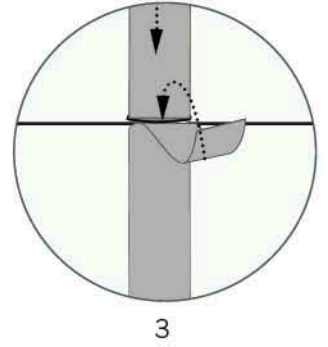
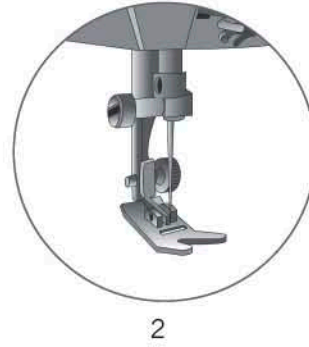
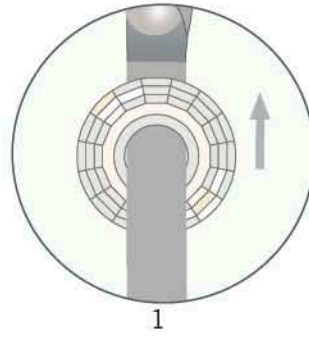
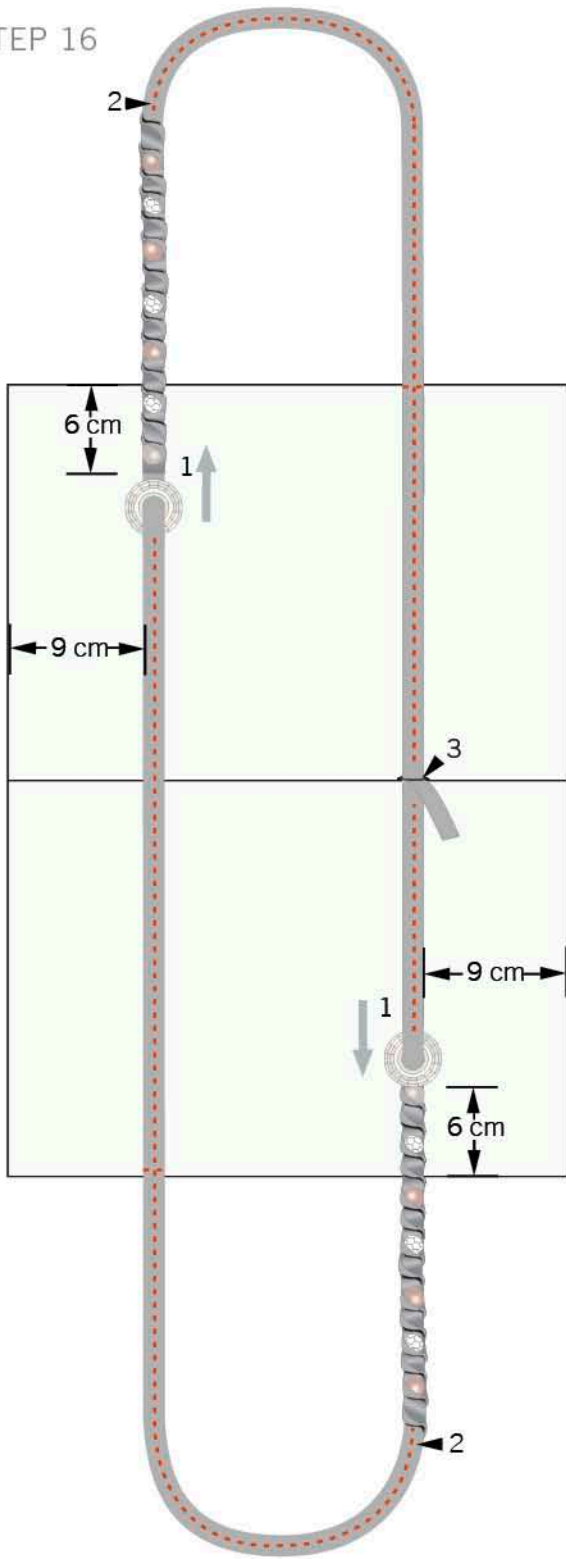

Scale 1:5

STEP 17

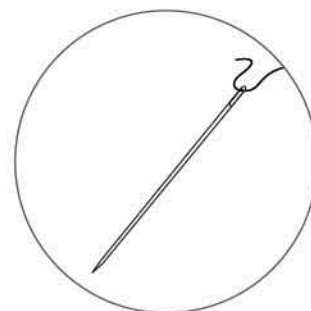
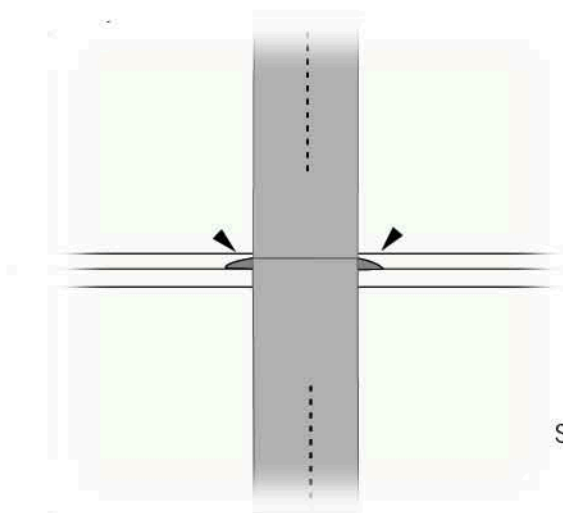

Scale 1:5

STEP 18

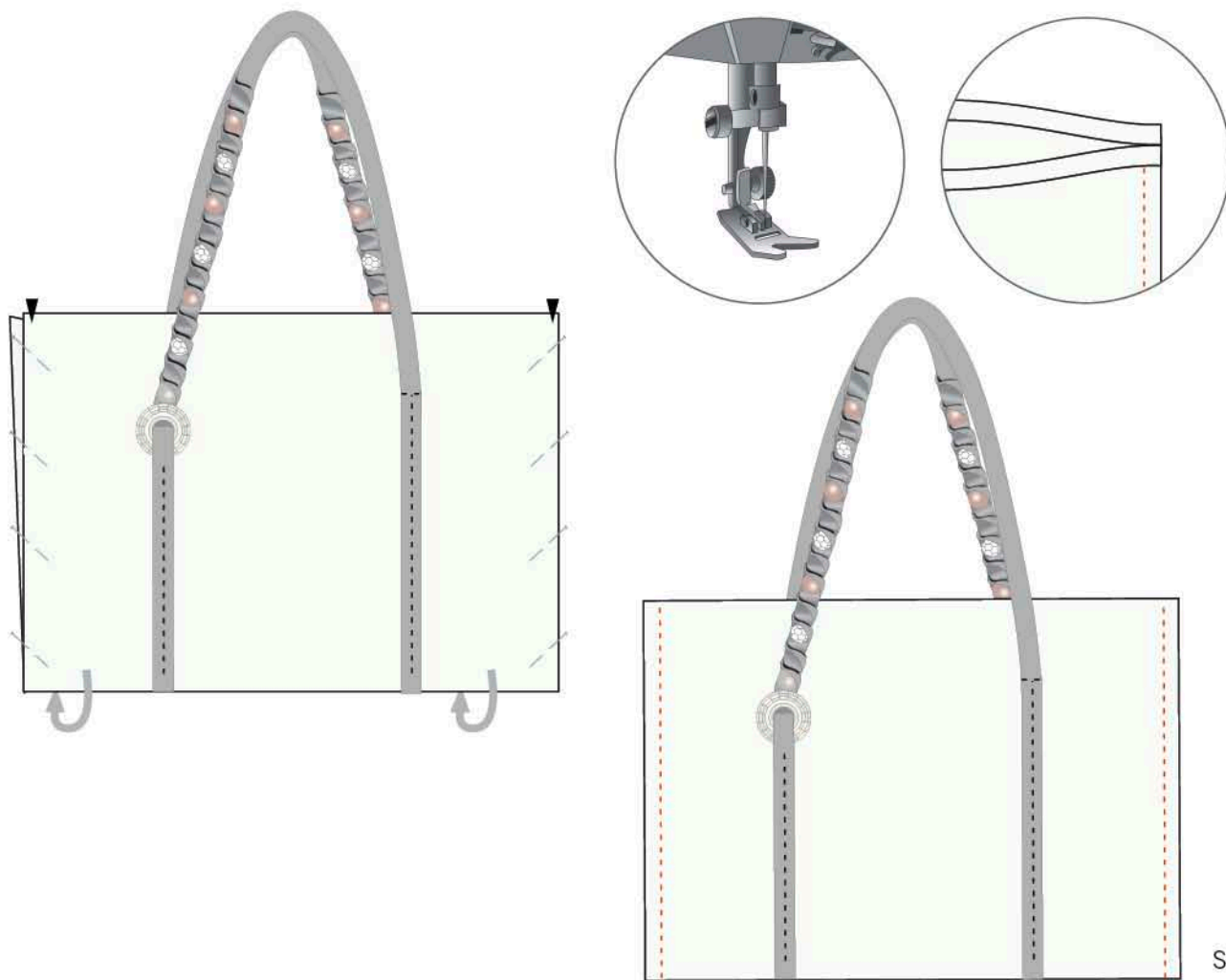

STEP 19

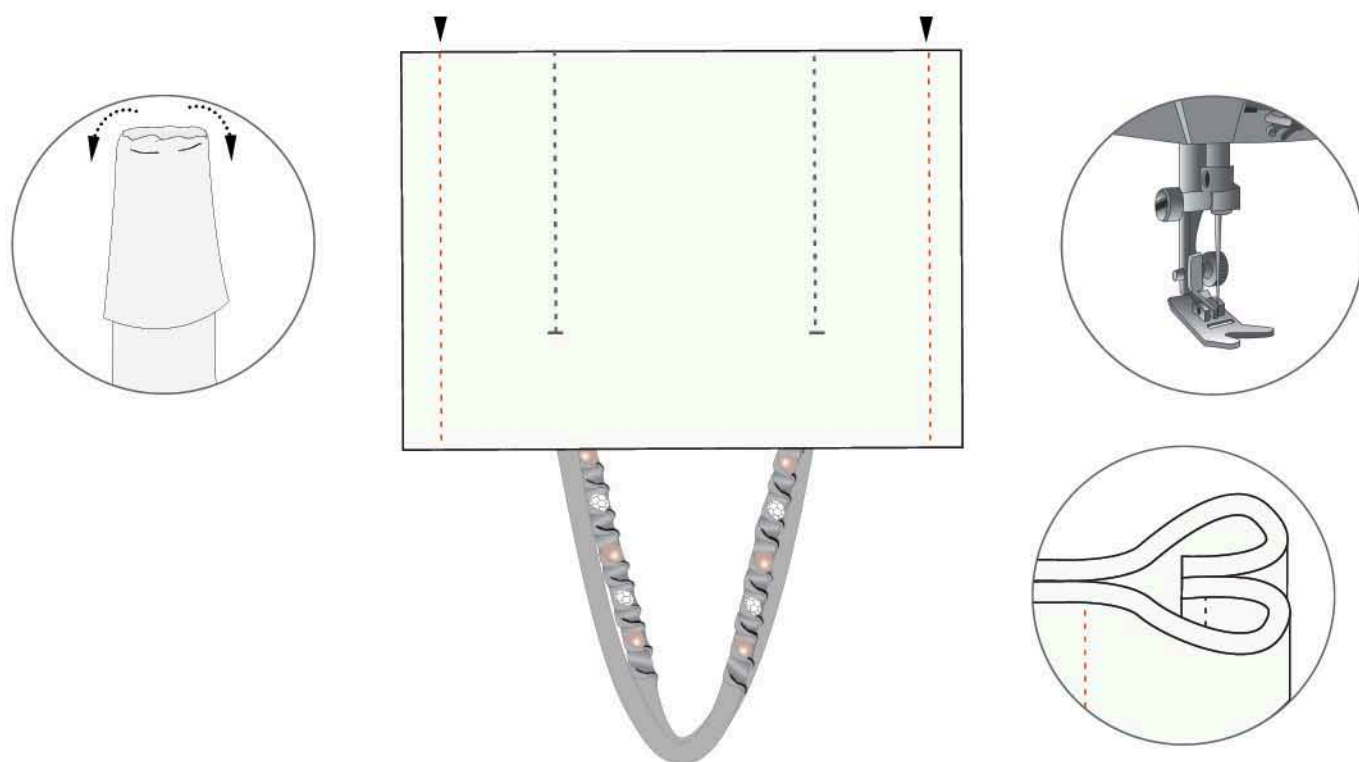

STEP 20

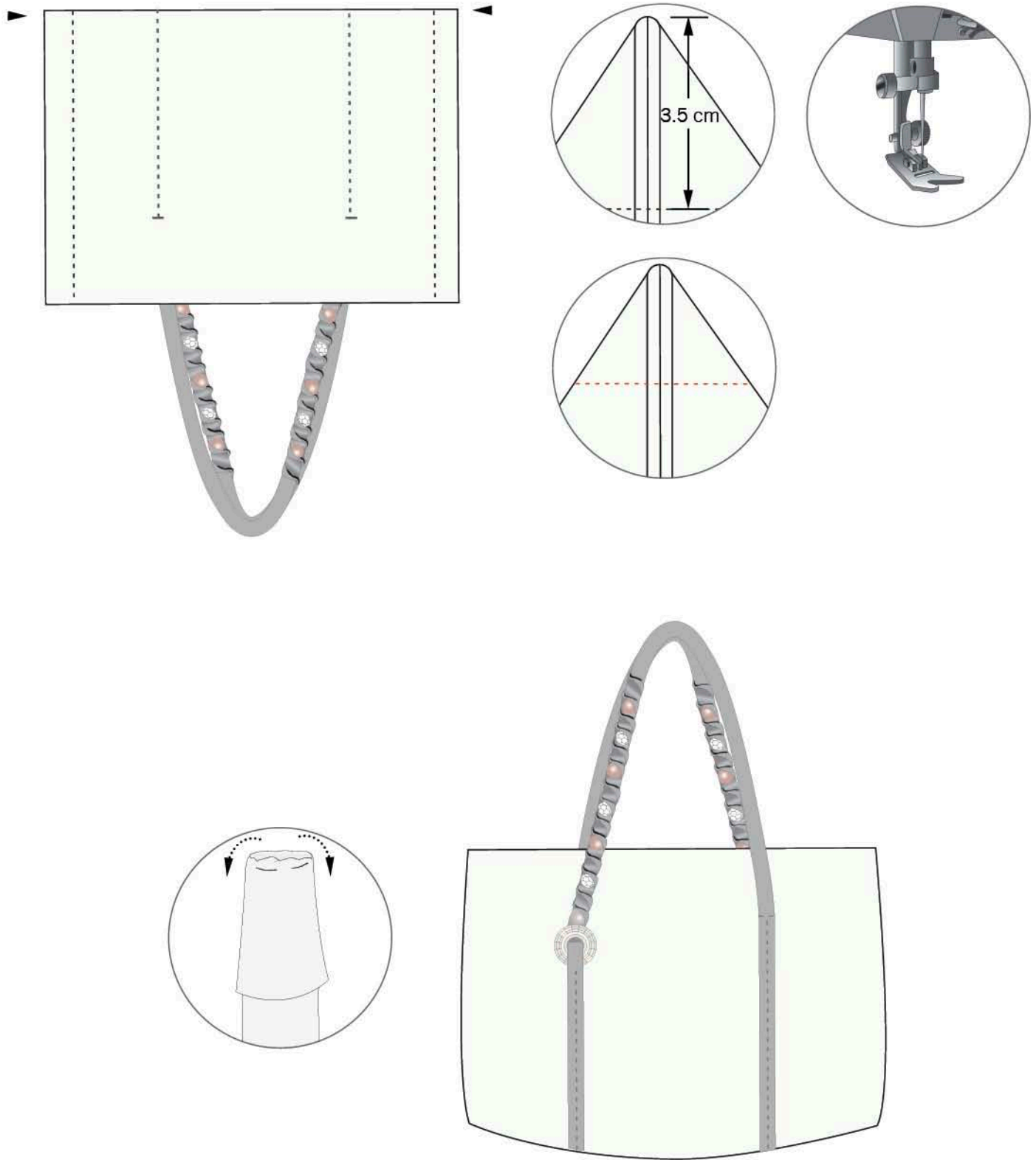

- STEP 1: Cut two 2.4 m pieces of ribbon and pin both pieces together.
- STEP 2: Thread a needle with 1 m of sewing silk. Measure 28 cm in on the ribbons and sew them together with a stitch (this stitch will be removed later on).
- STEP 3: Fold the ribbon as shown in the illustration. Fix folded part with a pin.
- STEP 4: Sew the 2 bands with approximately 4 back stitches. Slide on one CRYSTALLIZED™ Crystal Pearl article 5811 14 mm Crystal Light Grey Pearl onto needle and fix it with a stitch – go through the Crystal Pearl twice and fix again with another stitch. Stitch with needle to back side and turn so this side is now in front.
- STEP 5: Stitch 1.5 cm to left and turn the left side of the ribbon over to right side (see illustration).
- STEP 6: Slide on one CRYSTALLIZED™ Crystal Pearl article 5811 12 mm Crystal Platinum Pearl then turn 90° to right side (look at illustration).
- STEP 7: Stitch approximately 1.5 cm to left and fold left ribbon again to right side. Turn the entire ribbon again 90° to right side. Repeat steps 5 – 7 twelve times using the CRYSTALLIZED™ Crystal Pearl and Beads mentioned below in the order indicated.  
(You have already used the Crystal Pearl 14 mm (Crystal Light Grey Pearl) and 12 mm (Crystal Platinum Pearl). Always make one stitch without a CRYSTALLIZED™ - Swarovski Element and one with.)
- CRYSTALLIZED™ Bead article 5000, 14 mm, Crystal  
CRYSTALLIZED™ Crystal Pearl article 5811, 12 mm, Crystal Light Grey Pearl  
CRYSTALLIZED™ Crystal Pearl article 5811, 14 mm, Crystal Platinum Pearl  
CRYSTALLIZED™ Crystal Pearl article 5811, 12 mm, Crystal Light Grey Pearl  
CRYSTALLIZED™ Bead article 5000, 14 mm, Crystal  
CRYSTALLIZED™ Crystal Pearl article 5811, 12 mm, Crystal Light Grey Pearl  
CRYSTALLIZED™ Crystal Pearl article 5811, 14 mm, Crystal Platinum Pearl  
CRYSTALLIZED™ Crystal Pearl article 5811, 12 mm, Crystal Light Grey Pearl  
CRYSTALLIZED™ Bead article 5000, 14 mm, Crystal  
CRYSTALLIZED™ Crystal Pearl article 5811, 12 mm, Crystal Light Grey Pearl  
CRYSTALLIZED™ Crystal Pearl article 5811, 14 mm, Crystal Platinum Pearl  
CRYSTALLIZED™ Crystal Pearl article 5811, 12 mm, Crystal Light Grey Pearl
- STEP 8: Fold the ribbon first right and then down as shown in the illustration. Sew together with 2 back stitches. Slide on one CRYSTALLIZED™ Crystal Pearl article 5811 12 mm (Crystal Light Grey Pearl) and sew with 1 back stitch.
- STEP 9: Sew on the Crystal Pearl article 5811 12 mm (Crystal Light Grey Pearl), go through the Crystal Pearl twice and end with 4 back stitches. Cut the sewing silk off.
- STEP 10: Fix folded part with a stitch (which will be removed later on) and make a knot.
- STEP 11: Measure up 81.5 cm from the stitch in step 10. Then fix it again with a stitch as shown. Repeat steps 3 - 11.
- STEP 12: Cut a 106x37 cm piece of the cotton.
- STEP 13: Fold in half and sew the short side (37 cm side) together. Keep 2 cm open as shown in the illustration!
- STEP 14: Turn piece so that seam is in the middle.
- STEP 15: Iron the seam as you see in the illustration. Turn the seam inside after ironing.

- STEP 16: Place the ribbon with crystals onto the seam and slide on two CRYSTALLIZED™ Pendants article 6039 38 mm in Crystal Silver Shade.  
Then sew the ribbon onto the bag with a sewing machine (see illustration). Tuck the ends into the 2 cm slot left open in step 13.
- STEP 17: Sew the 2 cm opening closed by hand.
- STEP 18: Sew a French seam. Fold the piece into a bag and affix with pins on both sides. Sew seams with sewing machine on both sides see arrows in picture in illustration.
- STEP 19: Turn inside out and sew 1 cm in from seam made in step 18 (refer to the illustration: in the magnifier, the top view is visible).
- STEP 20: Sew both corners: Sew in 3.5 cm from the corner as shown in the illustration. Then turn the bag right side out.