

CREATE
YOUR STYLE with
CRYSTALLIZED™
-Swarovski Elements





DESIGN PROJECT
CHRISTMAS DECORATION
CHRISTMAS BOOT
& CHRISTMAS BELL

CHRISTMAS DECORATION CHRISTMAS BOOT



CRYSTALLIZED™ – Swarovski Elements

Materials for one bat

Article	Product Group	Article No.	Amount	Size	Colour	Colour Code
	Beads	5005	1 pc.	12 mm	Crystal Copper	001 COP
	Beads	5005	1 pc.	16 mm	Crystal Copper	001 COP
	Beads	5328	56 pcs.	4 mm	Crystal Metallic Light Gold 2x	001 MLG2

Supplies & Tools

Supplies

- Cotton
- Embroidery thread, dark red, Ø 0.5mm, 2m
- Fabric, dark red, 30 x 30cm
- Fabric, fuchsia, 20 x 20cm
- Fabric, light red, 20 x 20cm
- Ribbon, dark red, Ø 1.5mm, 30cm

Tools

- Beading needle
- Double sided tape
- Embroidery needle
- Pins
- Scissors
- 1 Sheet of paper, A4

Level of design: INTERMEDIATE

Pattern only – when creating the “Christmas Boot”, please refer to the instruction for the “Christmas Bell”.

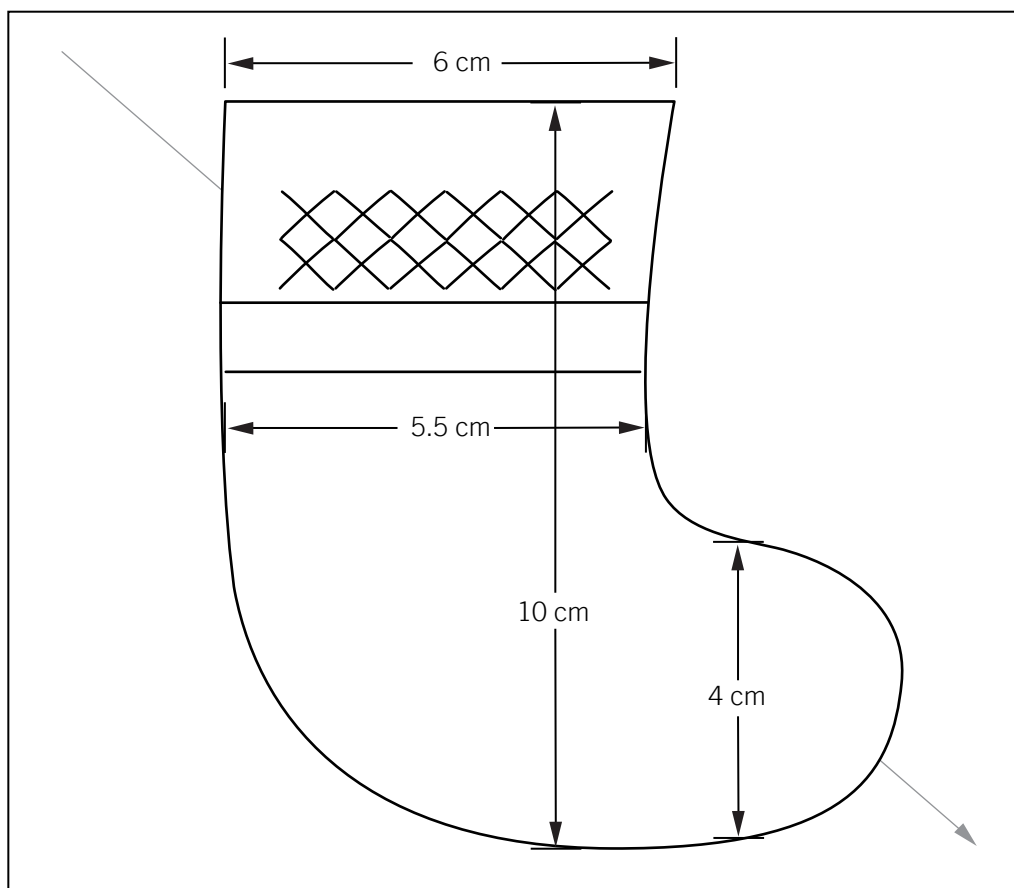



CHRISTMAS DECORATION CHRISTMAS BELL



CRYSTALLIZED™ – Swarovski Elements

Materials for one bat

Article	Product Group	Article No.	Amount	Size	Colour	Colour Code
	Beads	5005	1 pc.	16 mm	Crystal Copper	001 COP
	Beads	5328	72 pcs.	4 mm	Crystal Metallic Light Gold 2x	001 MLG2

Supplies & Tools

Supplies

Cotton
Embroidery thread, dark red, Ø 0.5mm, 2m
Fabric, dark red, 20 x 40cm
Fabric, fuchsia, 20 x 20cm
Fabric, light red, 20 x 20cm
Nylon thread, Ø 0.25, 10 cm
Ribbon, dark red, Ø 1.5, 40 cm

Tools

Beading needle
Double sided tape
Embroidery needle
Pins
Scissors
1 Sheet of paper, A4

Level of design: INTERMEDIATE

Have also a look at the **text instruction** at the last page!

STEP 1

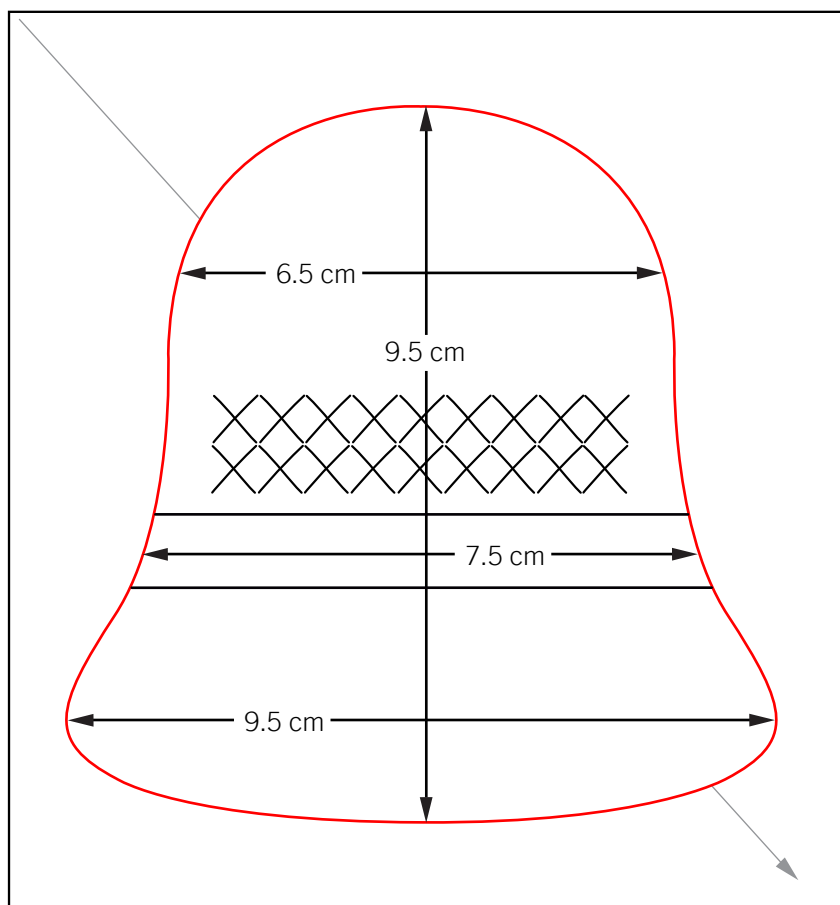

STEP 2

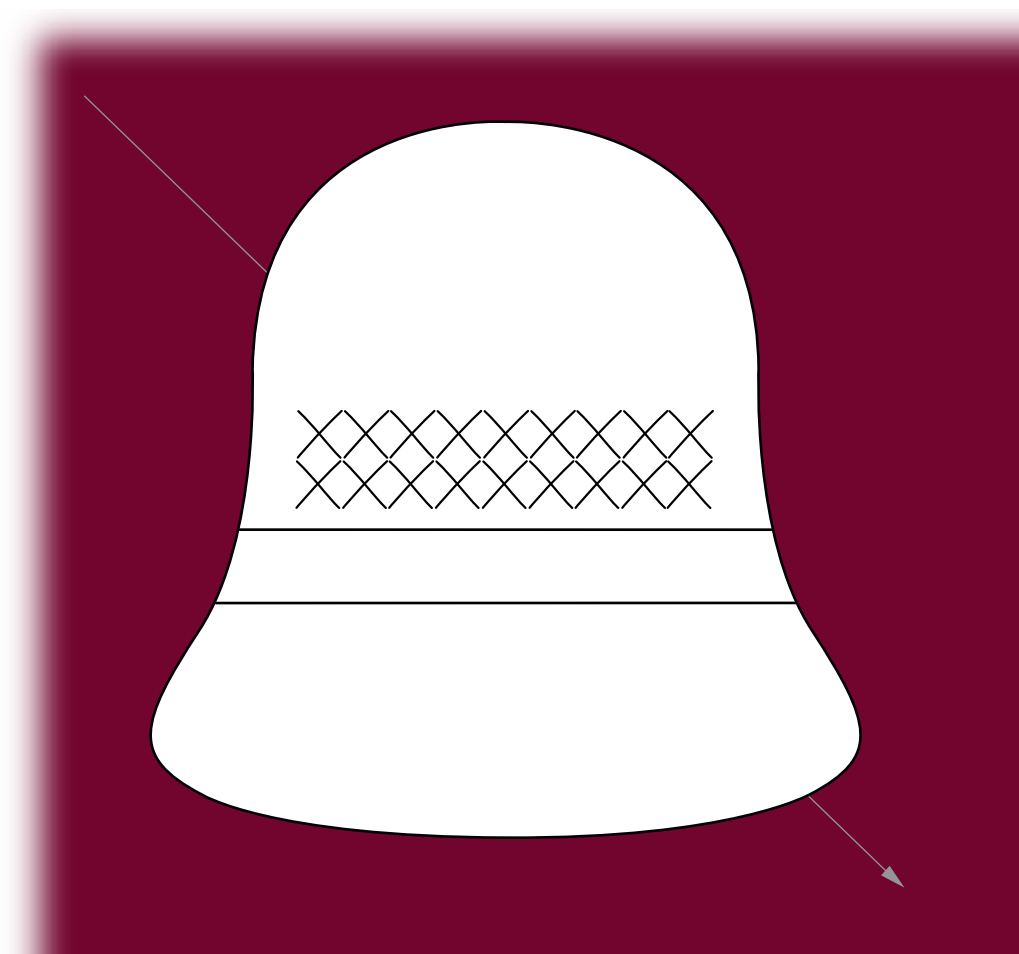
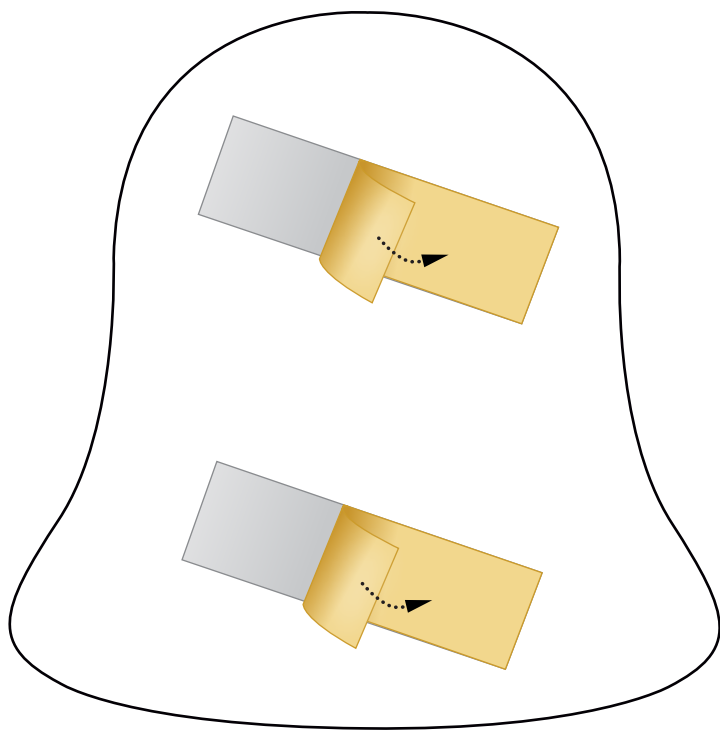

Repeat x1

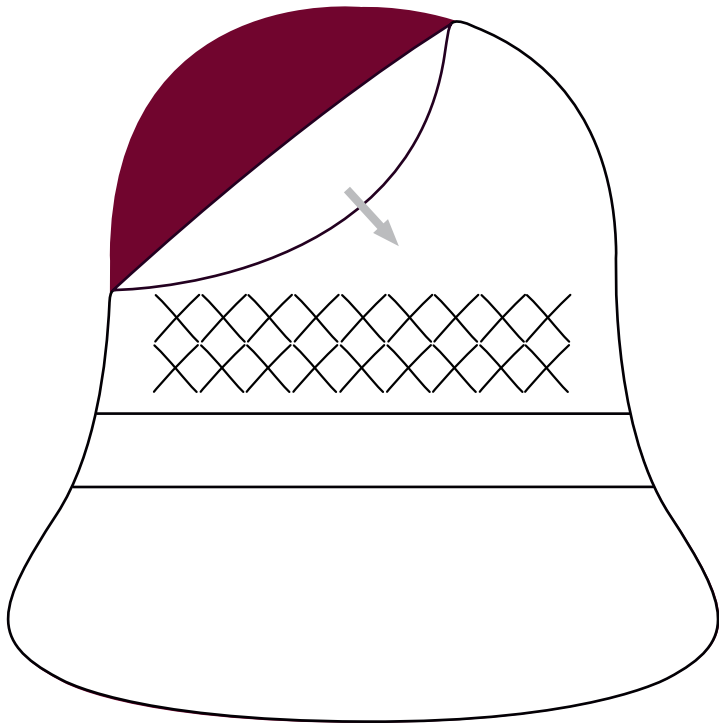

STEP 3

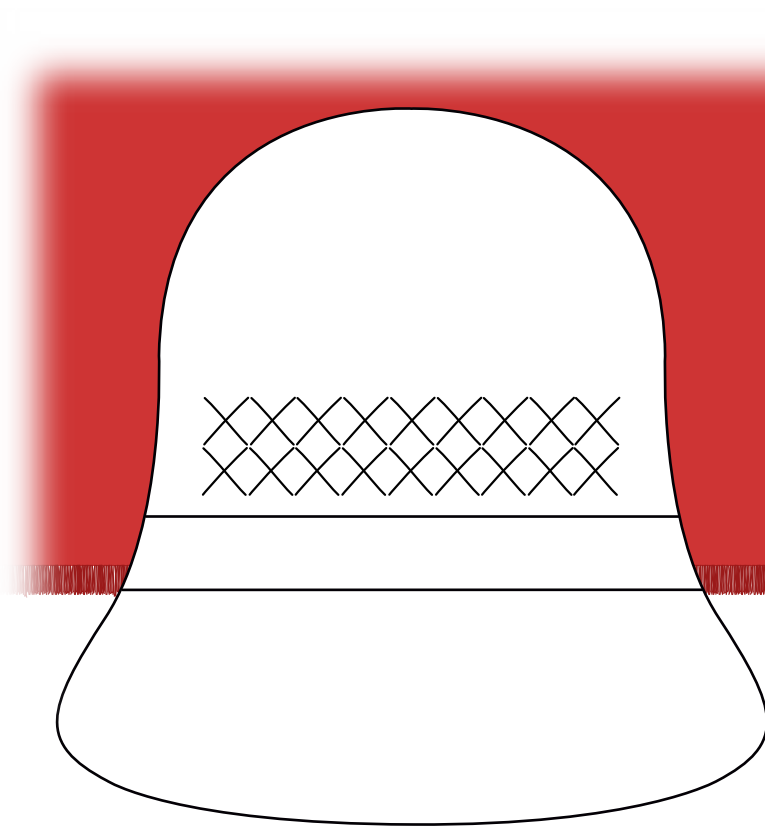

Repeat x1

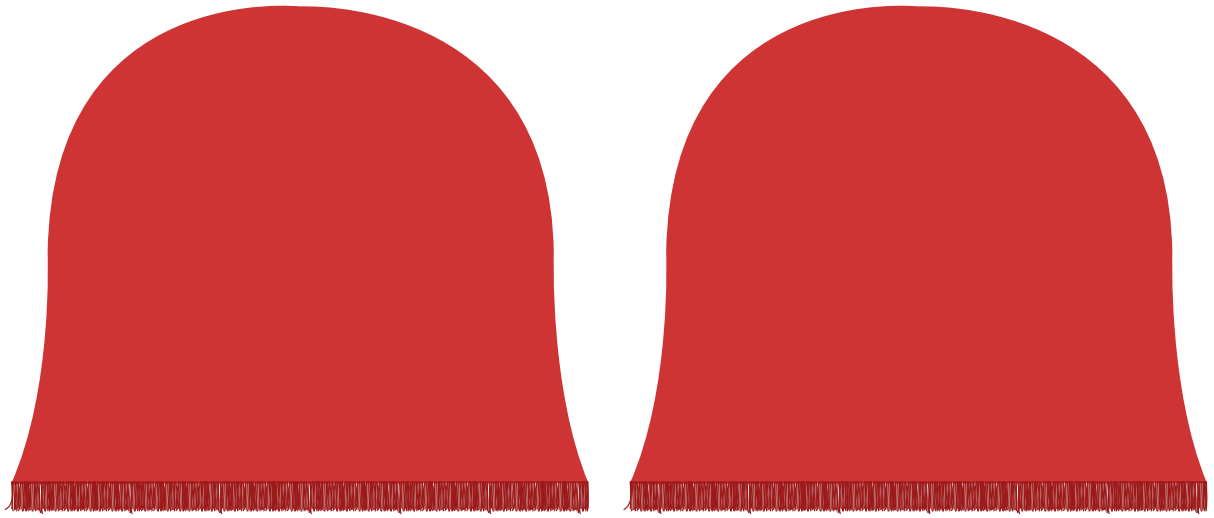

STEP 4

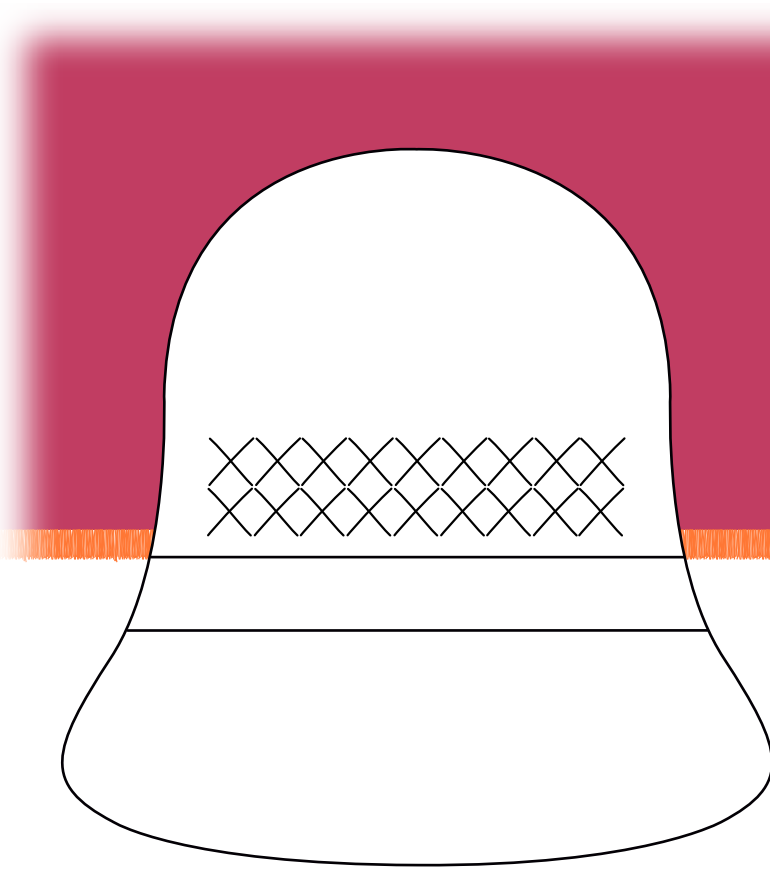

Repeat x1

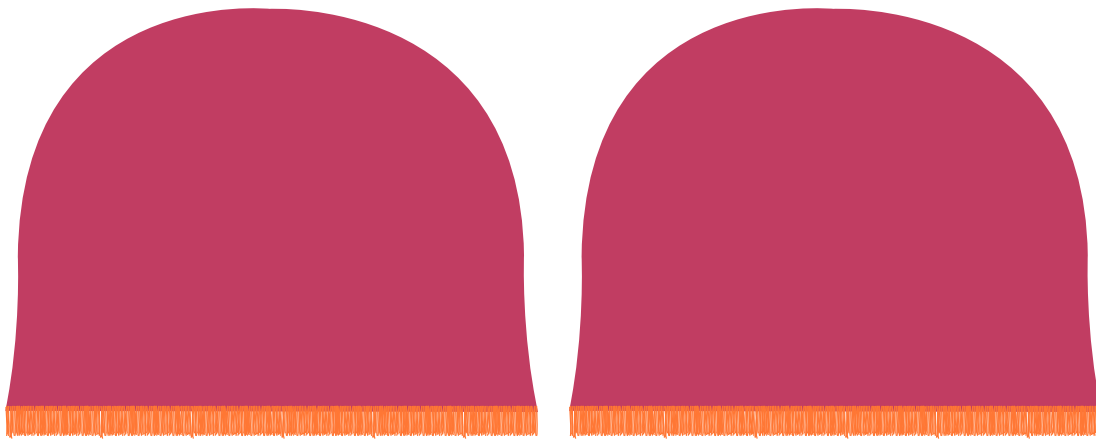

STEP 5

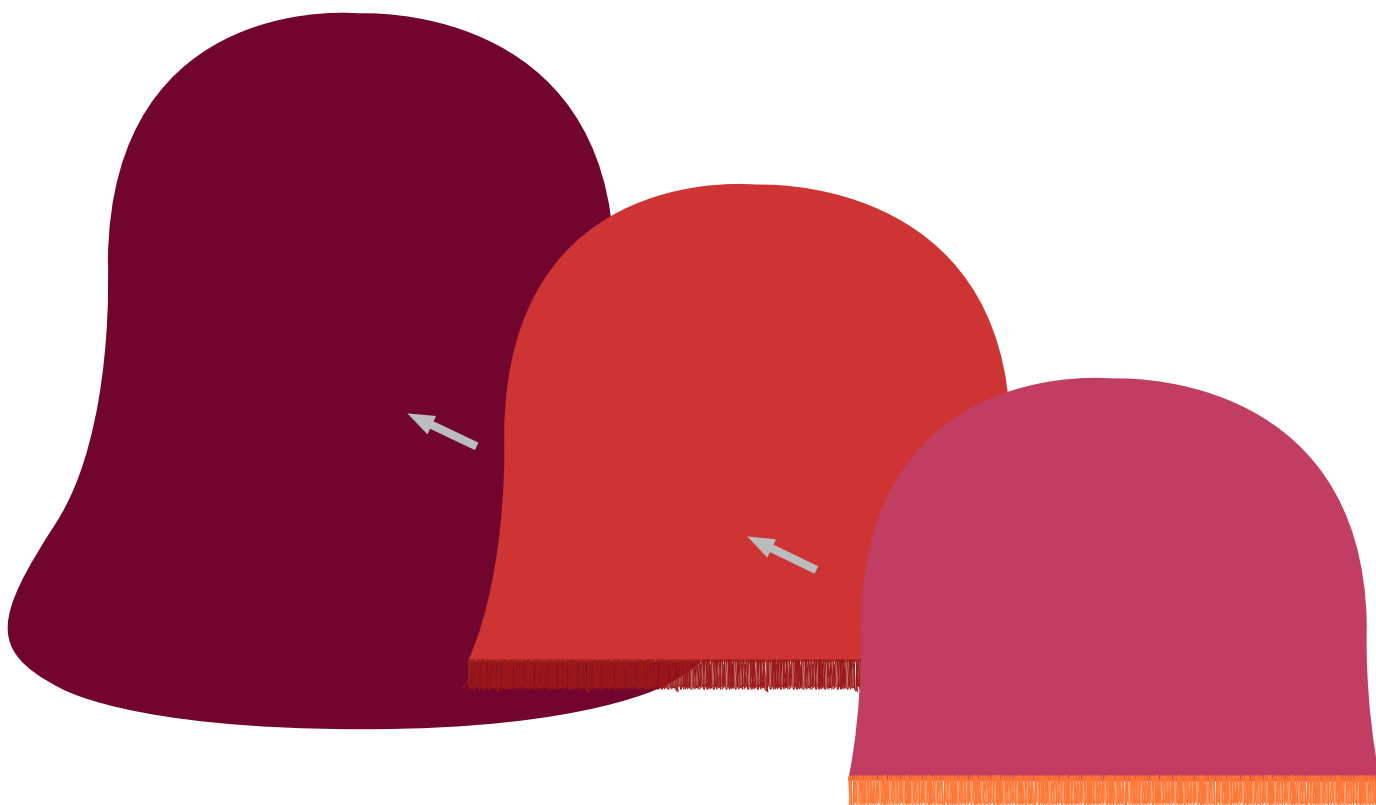

Repeat x1

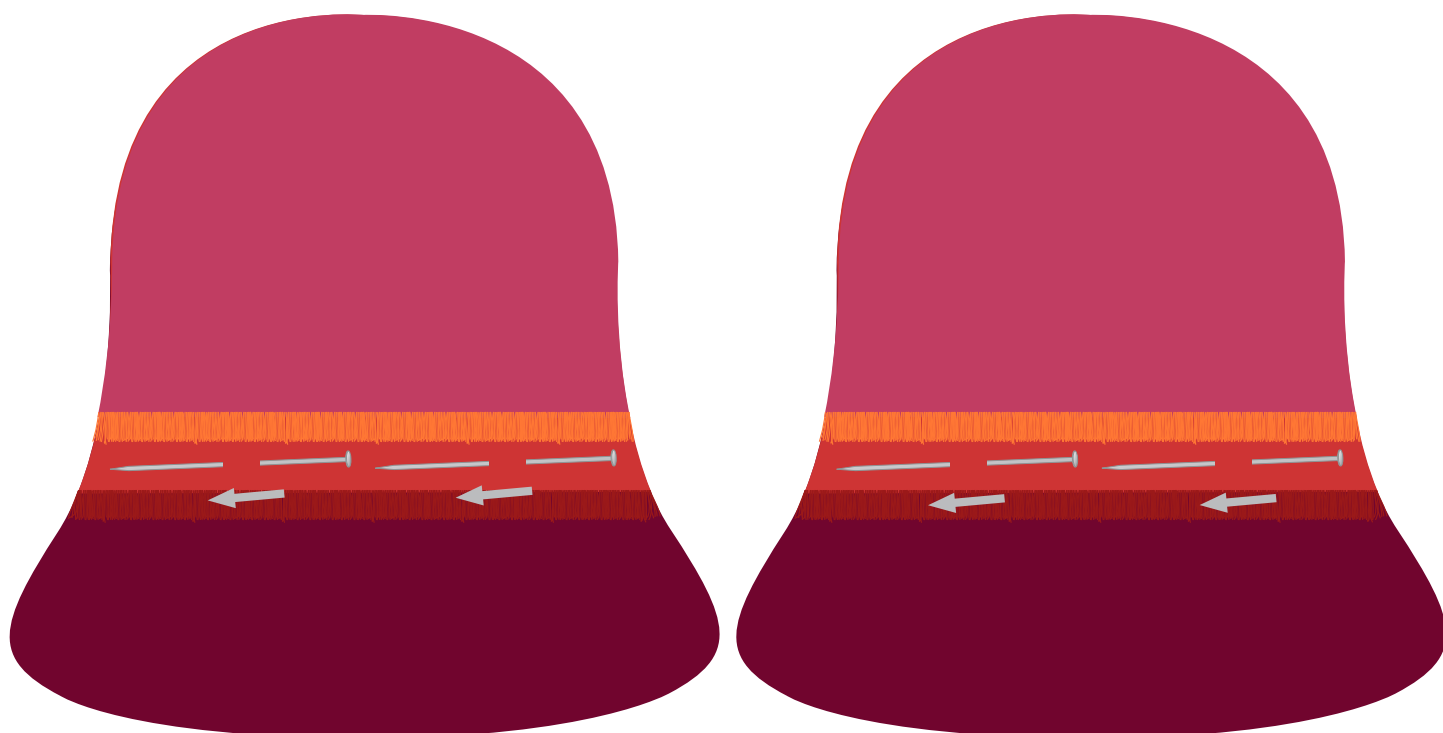

STEP 6

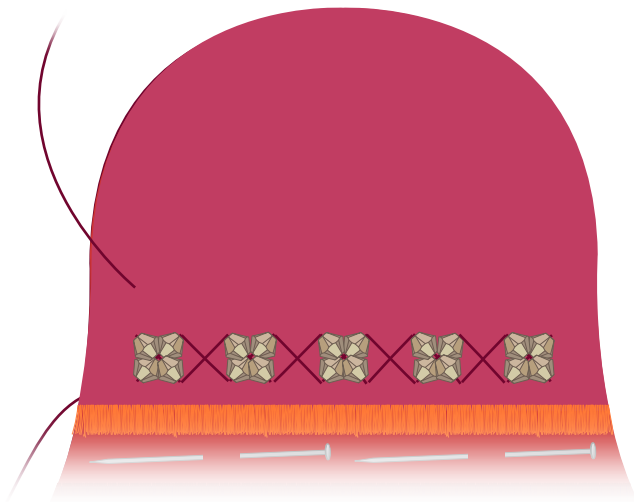
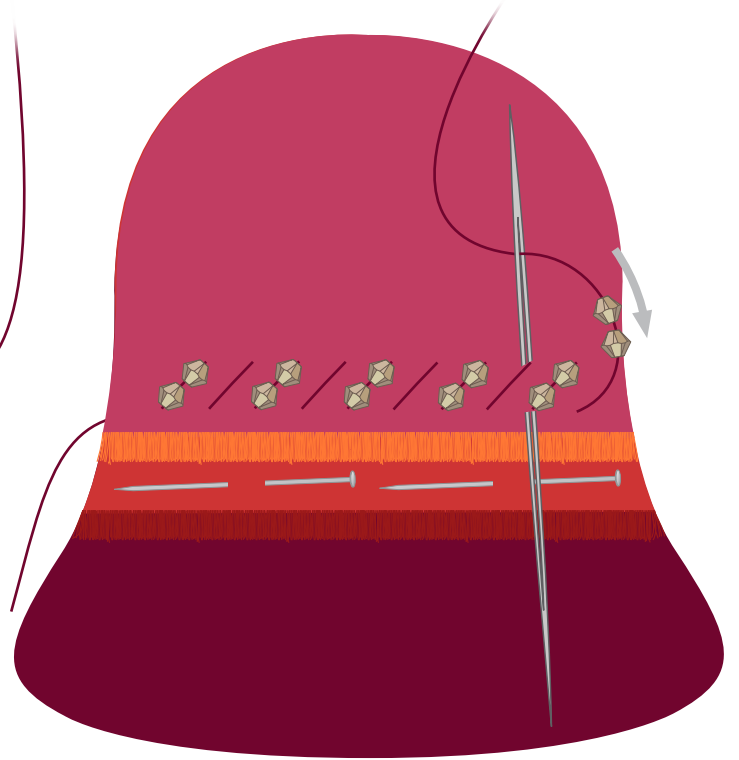
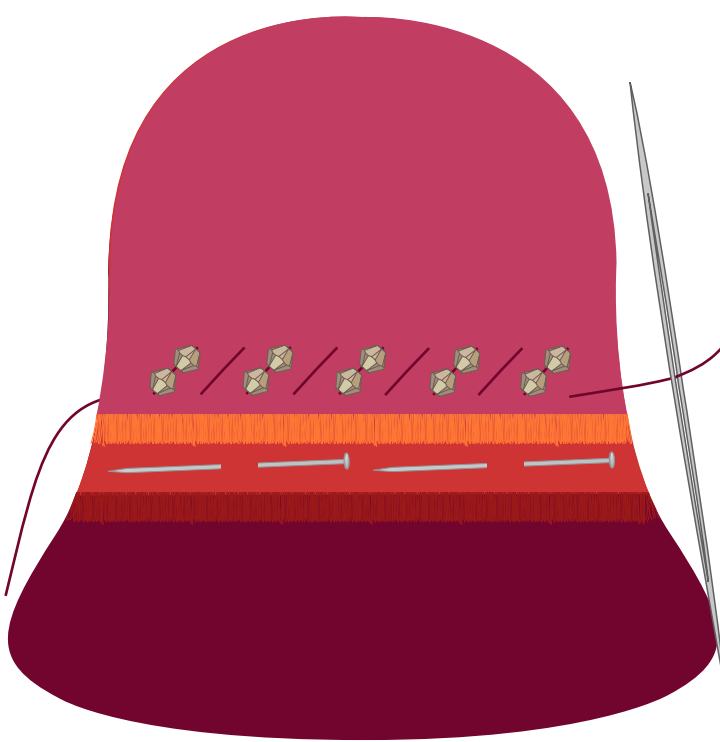
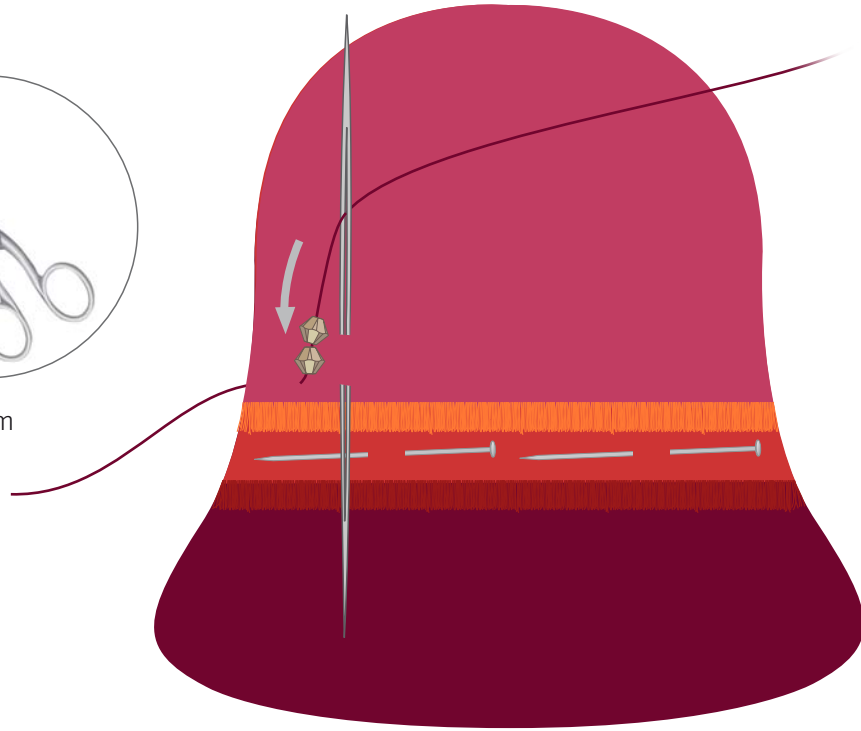
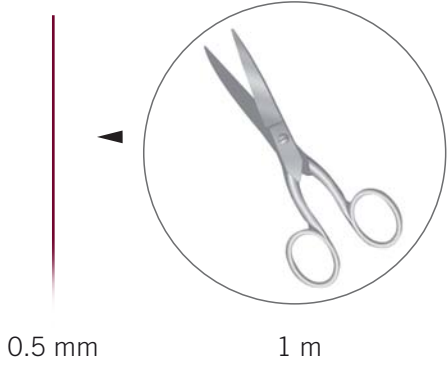

STEP 7

Repeat step 6:

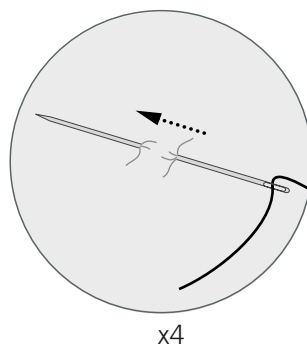
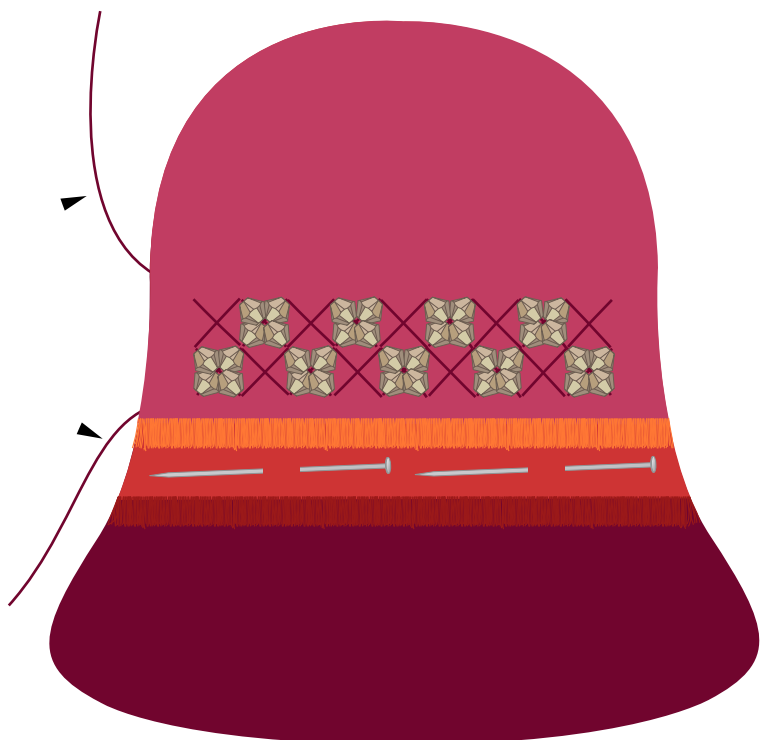

x4



Repeat steps 5 - 7 x1:

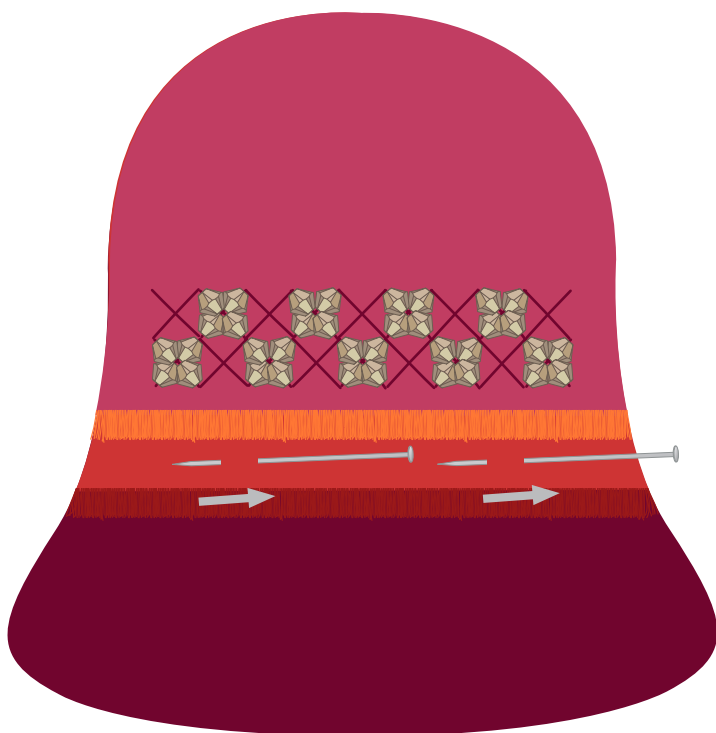
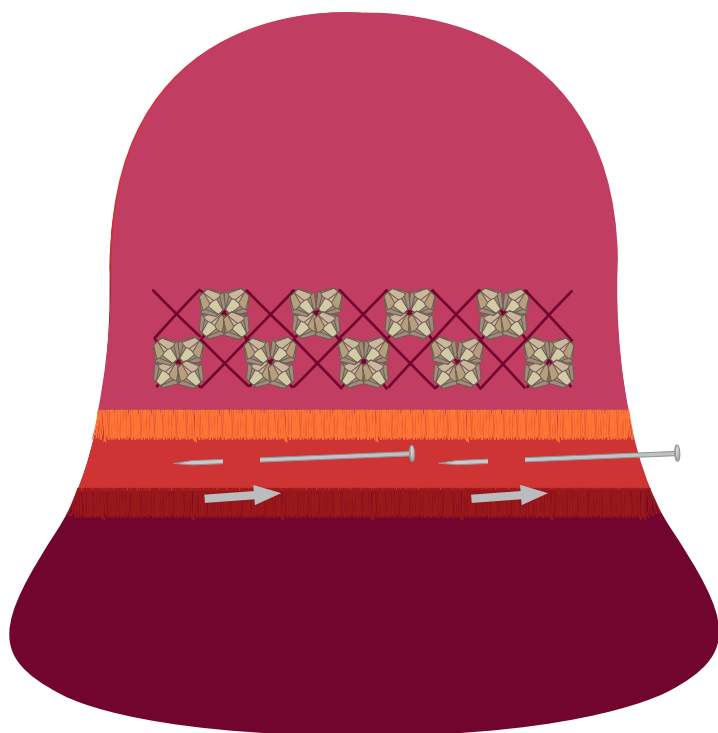

STEP 8

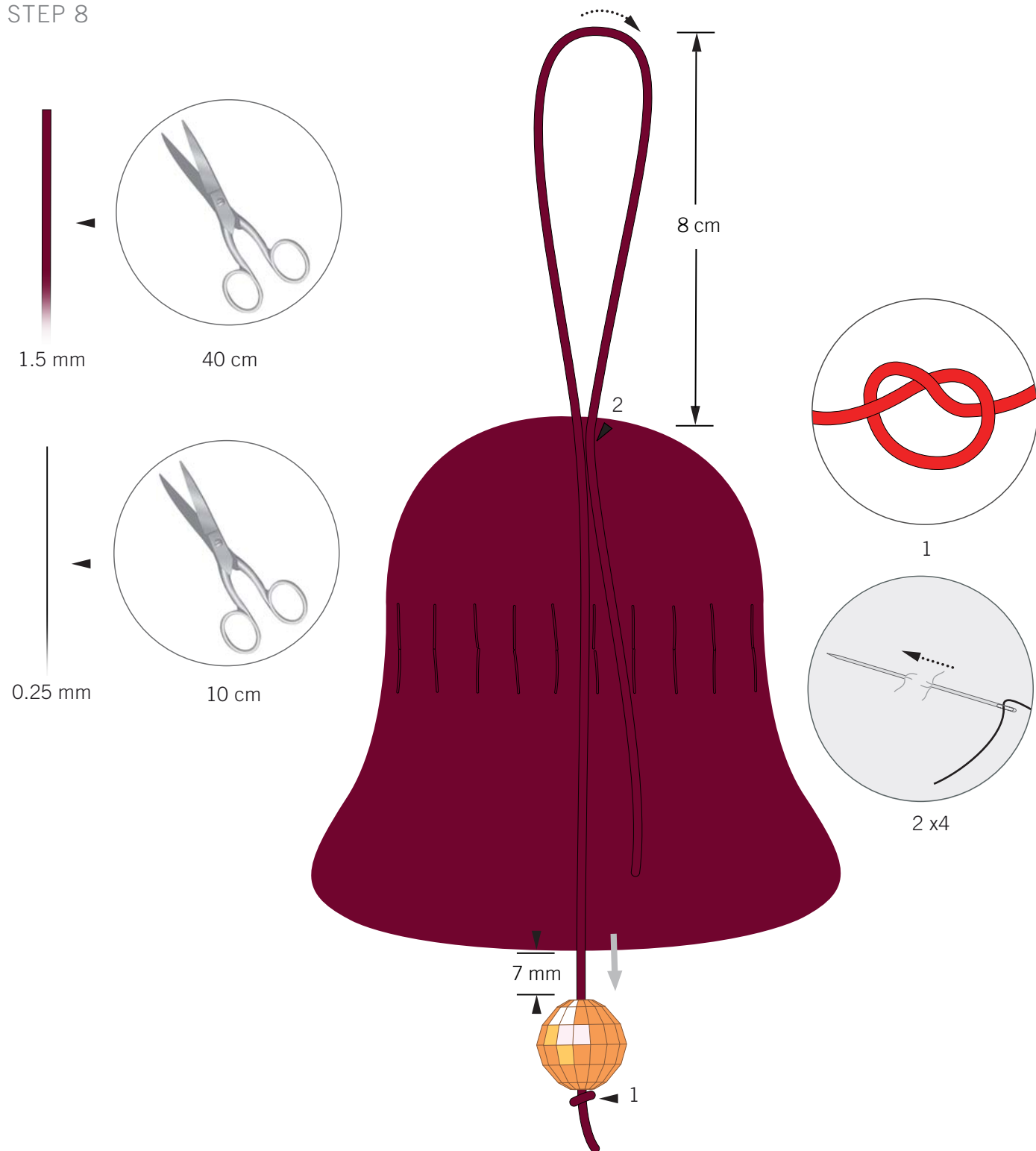

STEP 9

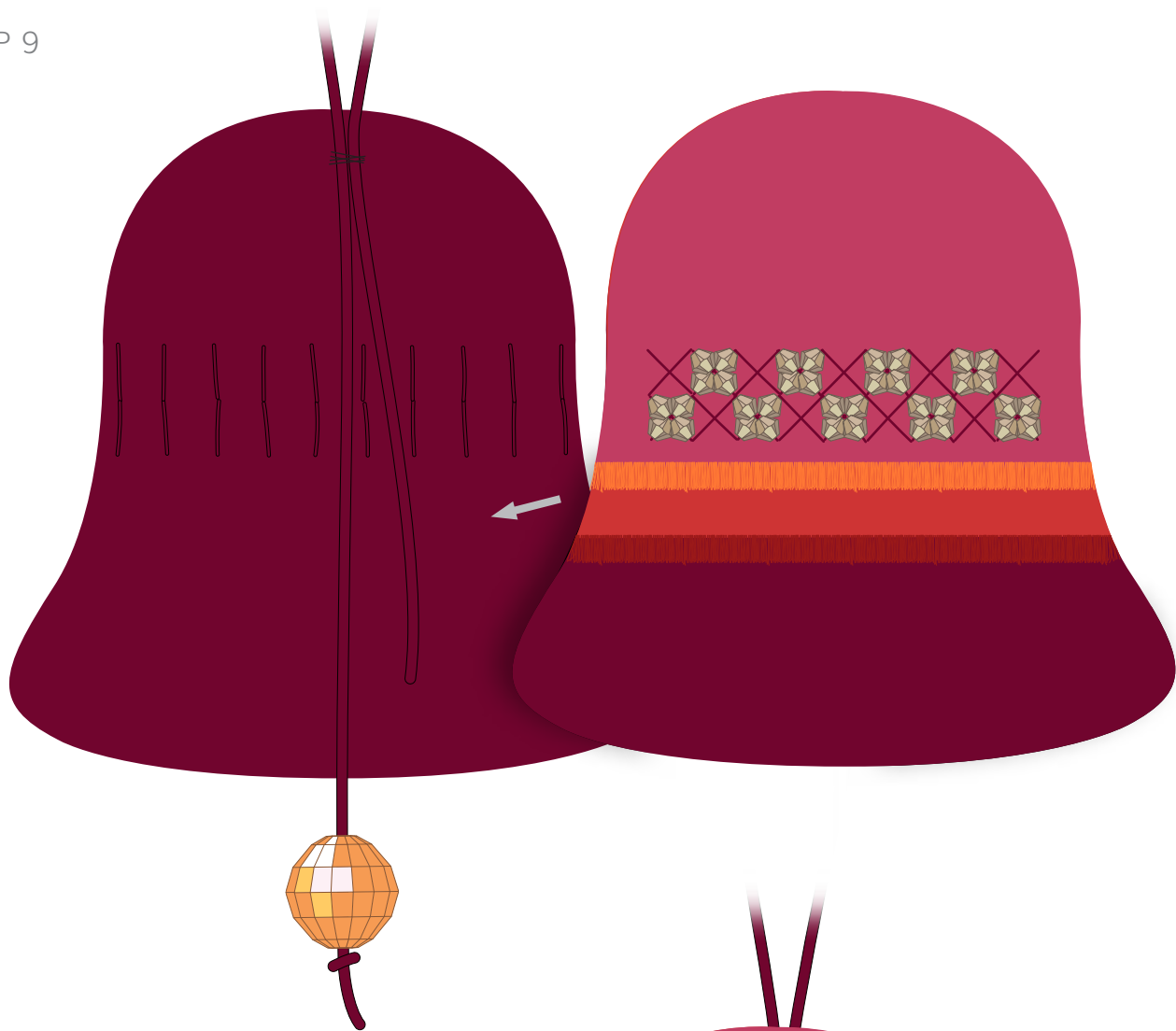

STEP 10

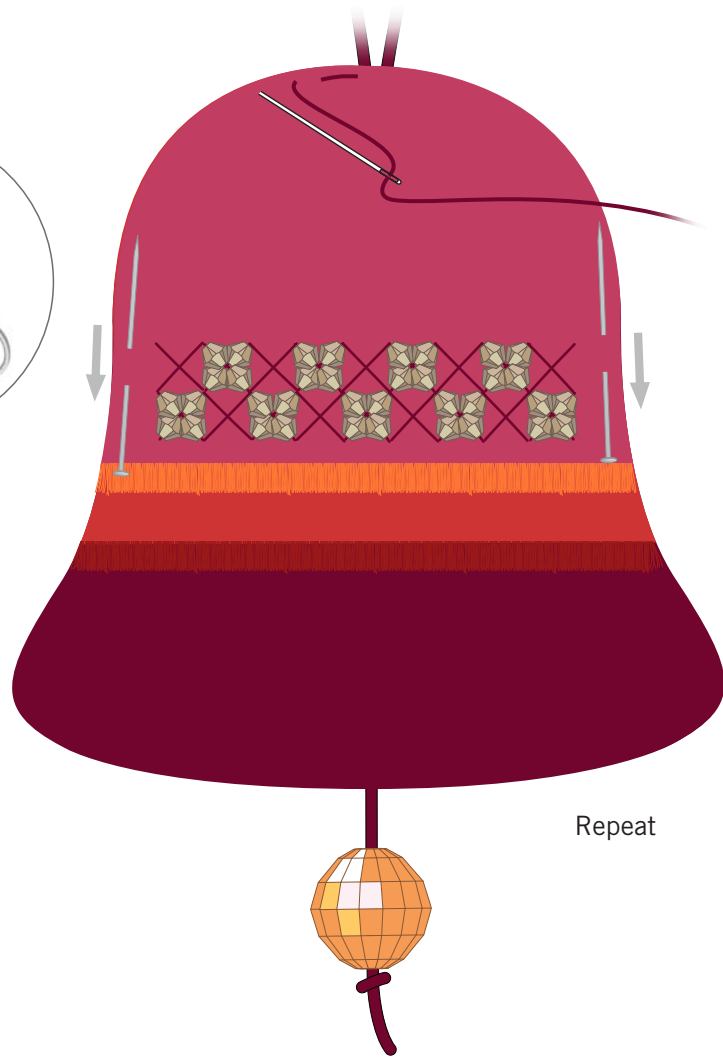
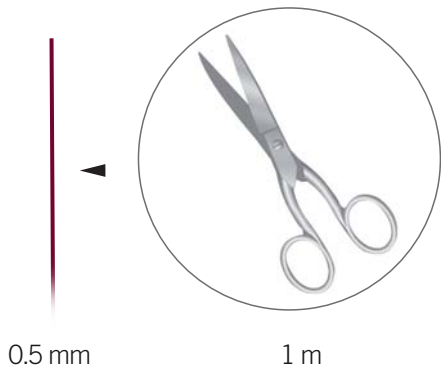

STEP 11



Repeat step 10

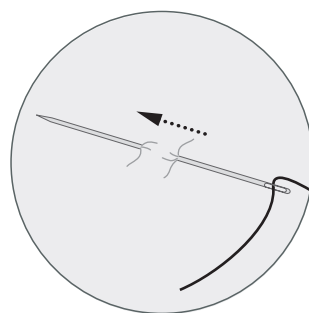

1 x4



2

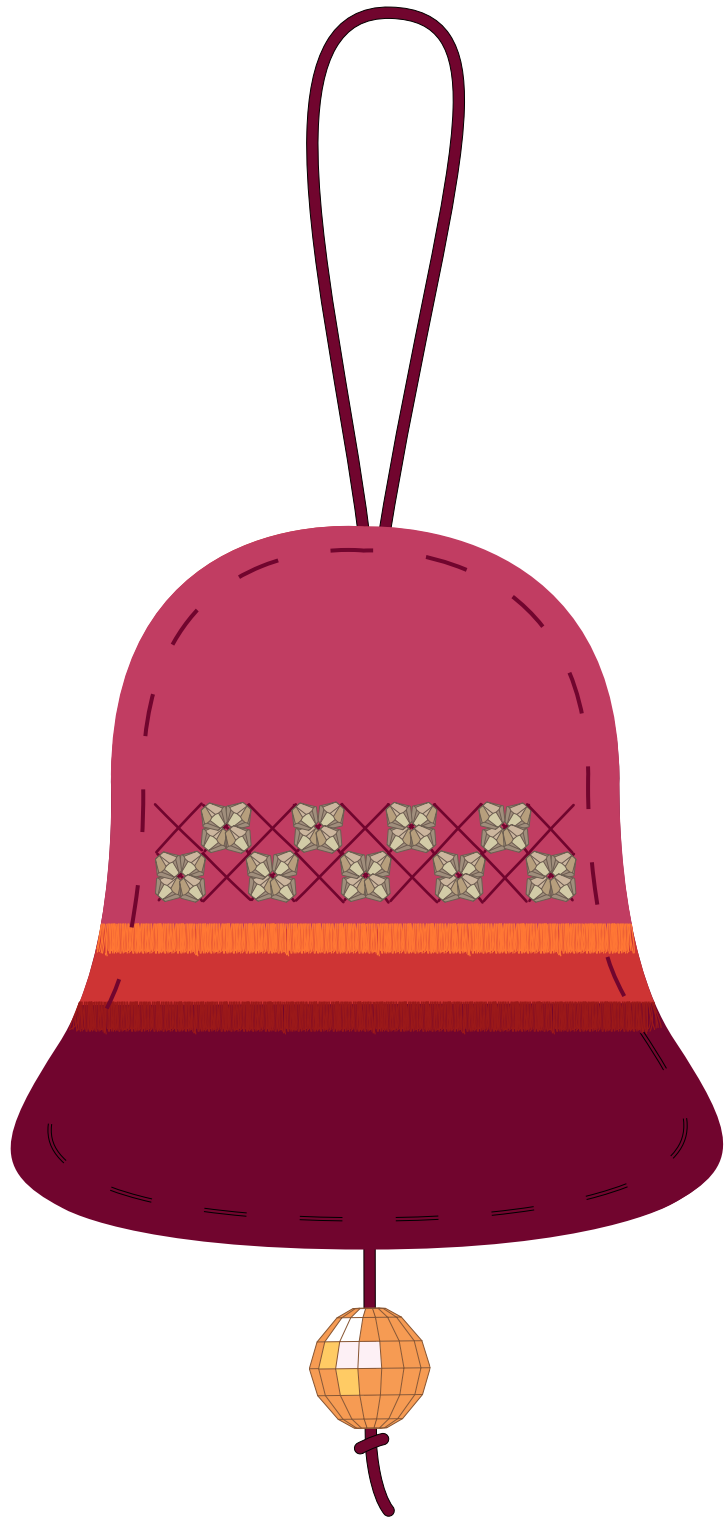

CREATE YOUR STYLE with CRYSTALLIZED™ – *Swarovski Elements* Design Project
Christmas Decoration Bell

- STEP 1: Print out the pattern and cut it out along the marked red line.
- STEP 2: Put some double sided tape behind the bell pattern and put it on the fabric. The light grey arrow shows the direction that the run of the thread of the fabric should have. Cut out as shown in illustrations then remove the pattern. Repeat this step one more time to get another bell.
- STEP 3: Place the bell pattern on the light red fabric as shown in the illustration & cut out the part of the bell shape and repeat it one more time to again get one more bell shape with the dark red fringes at the bottom, as shown in the illustration in this step.
- STEP 4: Put the bell pattern on the fuchsia coloured fabric exactly the way shown in the illustration so that the second line falls at the bottom of the fabric where the fringes end. As done before repeat this one more time to get another bell in this fabric colour.
- STEP 5: Fix the entire three parts one on top of each other with some pins as shown.
- STEP 6: Cut 1 m of the dark red embroidery thread and using the beading needle stitch from back to the front without cutting the shorter end behind. Insert 2 CRYSTALLIZED™ Beads in Crystal Metallic Gold onto this thread and repeat this step 8 more times going in a diagonal stitching pattern as depicted in the illustration. Beads should be only inserted on ever other thread that is stitched as shown in the illustration.
- Move back in the opposite direction exactly the same way finishing this row as shown and come out at the point where you can start the next row as depicted in the illustrations.
- STEP 7: Repeat step 6 for the upper row, but this time start the first stitch without the CRYSTALLIZED™ Beads and then add to every other stitch the CRYSTALLIZED™ Beads as shown in the illustration. Make four back stitches with the left over thread on the back side and cut off the excess. Repeat steps 5–7 one more time to get another bell. Remove the pins as shown in the illustration.
- STEP 8: Cut 40cm from ribbon and 10cm from nylon thread for fixing the ribbon. Make a knot at the lower end of the thread marked as number 1 in the illustration and insert one CRYSTALLIZED™ Bead article 5005 16mm in Crystal Copper. Fold over the other end of the ribbon forming an 8cm loop over the bell as shown. Make 4 back stitches with nylon thread to fix the ribbon where number 2 is marked in the illustration.
- STEP 9: Now place the other bell on top of this bell as shown and secure them with pins.
- STEP 10: Cut 1 m nylon thread and start stitching the two bells together, stopping a bit before you completely stitch the two bells together and open the gap.
- STEP 11: Fill the bell with some cotton and repeat step 10 to complete stitching the two bells together. Make 4 back stitches at the point marked as number 1 and cut off the left over thread as shown in the illustration.