

CREATE
your STYLE™
with CRYSTALLIZED™ – Swarovski Elements

THE SEASON OF COSINESS

Get into the Christmas spirit

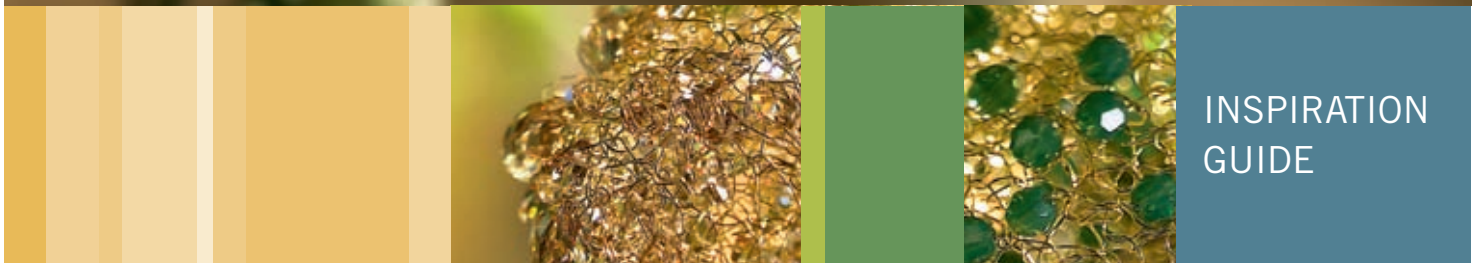

INSPIRATION
GUIDE

WHEN IT'S COLD OUTSIDE ...

The season for a little retreat



CRYSTALLIZED™
– Swarovski Elements

Fancy Stones
Art. 4139



Beads
Art. 5040



Pendants
Art. 6007



Pendants
Art. 6010



HANDCRAFT ATMOSPHERE MYSTERY

Long evenings in the winter time invite you to stay at home and enjoy the cosy atmosphere. The lights of the candles already anticipate Christmas Eve while you create a yet unseen handcrafted decoration.

In the night seemingly weightless crochet balls with dangling CRYSTALLIZED™ – Swarovski Elements Pendants will hover mysteriously on the Christmas tree branches and emanate a ceremonial spirit.





REACHING FOR THE STARS

Bring tradition to a new form





CRYSTALLIZED™
– Swarovski Elements

Beads
Art. 5000 

Beads
Art. 5040 

Beads
Art. 5301 

Beads
Art. 5650 

Beads
Art. 5601 

Pendants
Art. 6090 



WINTER LIGHT
SYMBOLISM
TRADITION
AMBIENCE

In times of early dawn the illuminated windows welcome those coming home. The starshaped window decorations with CRYSTALLIZED™ – Swarovski Elements are a reminiscence of the Russian Orthodox

culture with its mystic ornaments. As the most traditional of all Christmas symbols they reflect the light signalling an atmosphere of comfort, peace and acceptance representing an invitation to come in.



GIVE PLEASURE TO THE ONES YOU LOVE

It comes from the heart





CRYSTALLIZED™
– Swarovski Elements

Flat Backs
Art. 2483 

Beads
Art. 5000 

Beads
Art. 5040 

Beads
Art. 5301 

Crystal-it
Art. 75000 



INSPIRATION PRECIOUS PACKAGING SENSUALITY ADORNMENT

You just start with a plain square shaped piece of paper, simply fold it in Origami technique and the little box is ready. Convert it into a real treasure by

embellishing it with patterns of crystal varying in sizes by CRYSTALLIZED™– Swarovski Elements. A delightful gift box is ready to be filled and given away.







HIDE A LITTLE SECRET

Enjoy the precious packaging

CRYSTALLIZED™
– Swarovski Elements

Beads
Art. 5000 

Beads
Art. 5040 

Crystal-it
Art. 75000 



SPARKLES SNOWFLOWERS SURPRISE

At first sight the pyramid shaped box can be interpreted as an abstraction of a Christmas tree. When opening it by using the exceptional mechanism accentuated by CRYSTALLIZED™ – Swarovski Elements

Beads it surprisingly transforms into a charming star shape. The sparkling crystals in a snowflake pattern create a wonderful Christmas spirit.

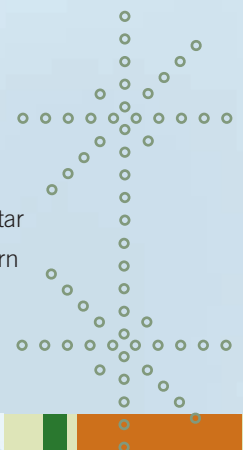

GREETINGS IN A NEW DIMENSION

Let joy be your messenger



GLUING/DECORATING PAPER

CRYSTALLIZED™
– Swarovski Elements

Flat Backs
Art. 2709



Crystal-it
Art. 75000



SAISONAL GREETINGS
MAGIC
SIMPLICITY
DEDICATION

The greeting card is made in the old Japanese Kirigami technique that is a variation of the famous Origami – transforming a simple piece of paper into a very personal message. The addressee will unfold

the flat card to a three-dimensional star arising in crystal sparkle by CRYSTALLIZED™ – Swarovski Elements knowing that this is a very personal and valuable gesture.



A WINTER'S TALE ...

Written in a Christmas card



WIRING/DECORATING PAPER

CRYSTALLIZED™
– Swarovski Elements

Crystal Pearls
Art. 5810



Crystal-it
Art. 75000



DELIGHTFUL CHRISTMAS CARD ETERNITY

The romantic story of winter, snow and long walks in an icy landscape is told through a card that unfolds as a Christmas tree. The affectionate

decoration with little Christmas balls made of Crystal Pearls by CRYSTALLIZED™ – Swarovski Elements makes it a noble gift.



CHRISTMAS GIFT BOX



CRYSTALLIZED™ – Swarovski Elements

Article	Product Group	Article No.	Amount	Size	Color	Color Code	Supplies
	Flat Backs	2483	4	10 mm	Crystal Dorado	001 DOR	Brass Wire, 3 mm, 60 cm Brass Cardboard, 20x20 mm, Dark Brown
	Flat Backs	2483	4	10 mm	Topaz	203	
	Beads	5000	1	4 mm	Crystal Dorado 2x	001 DOR 2x	
	Beads	5040	2	6 mm	Topaz	203	
	Beads	5040	3	8 mm	Topaz	203	
	Beads	5301	12	4 mm	Crystal Dorado 2x	001 DOR 2x	
	Beads	5301	8	3 mm	Topaz	203	
	Crystal-it	75000	4	3 mm	Topaz	203	
	Crystal-it	75000	228	2 mm	Topaz	203	
	Crystal-it	75000	84	3 mm	Crystal Dorado	001 DOR	
	Crystal-it	75000	60	2 mm	Crystal Dorado	001 DOR	

STEP 1

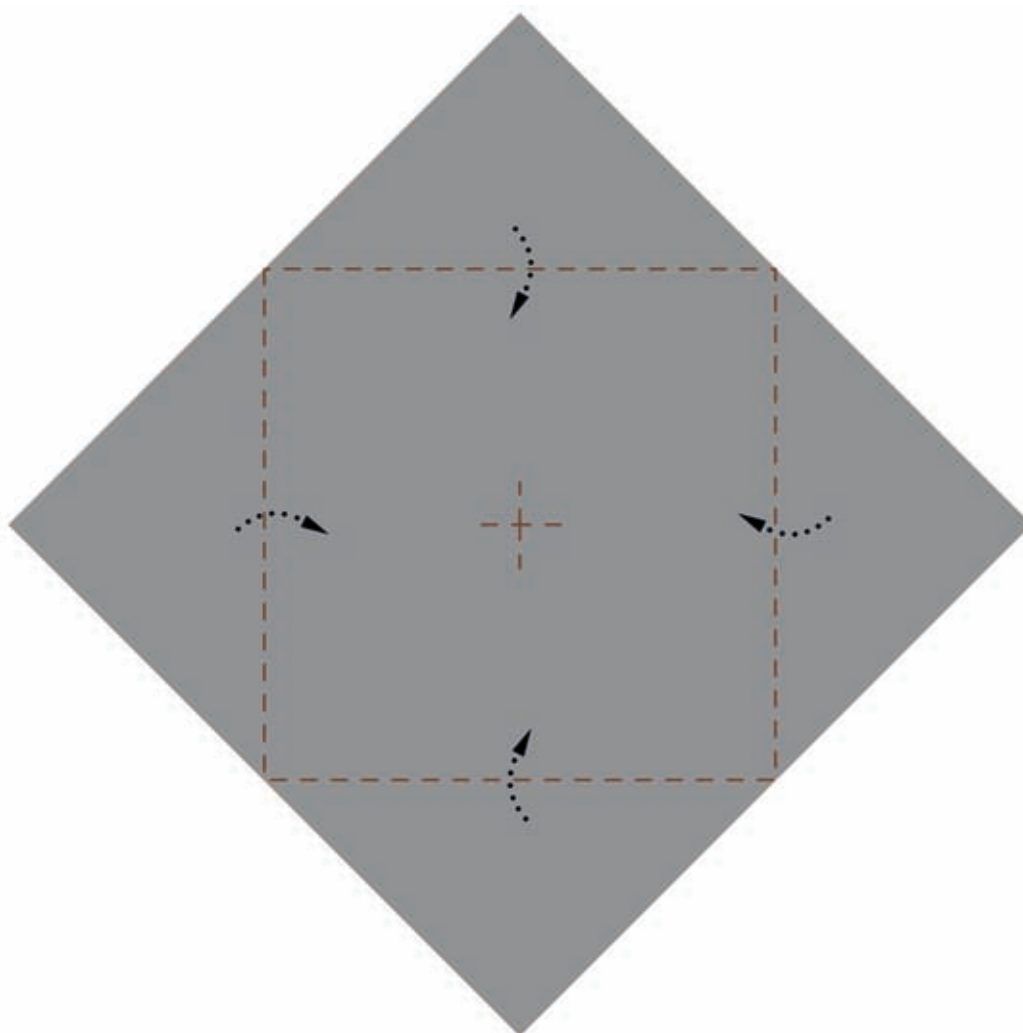

1:0.5

CHRISTMAS GIFT BOX



- Decorating Paper
- Gluing
- Wiring

STEP 2

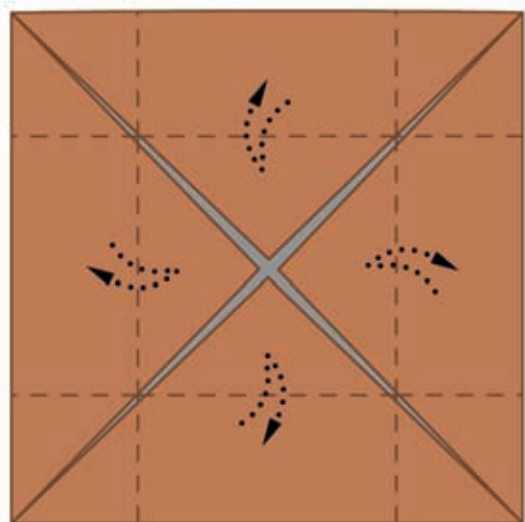

STEP 3

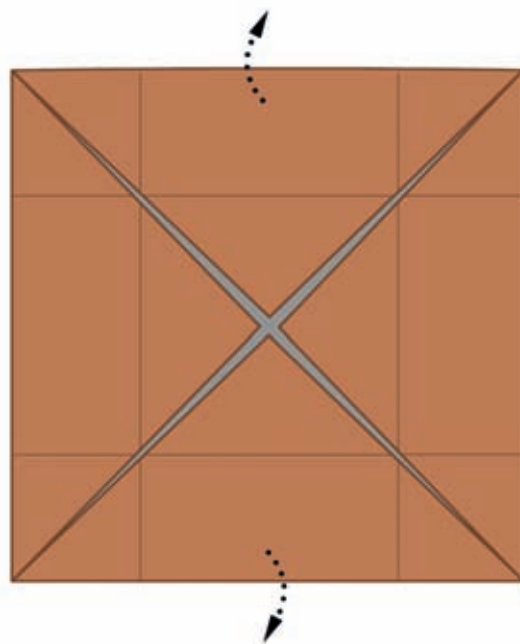

STEP 4

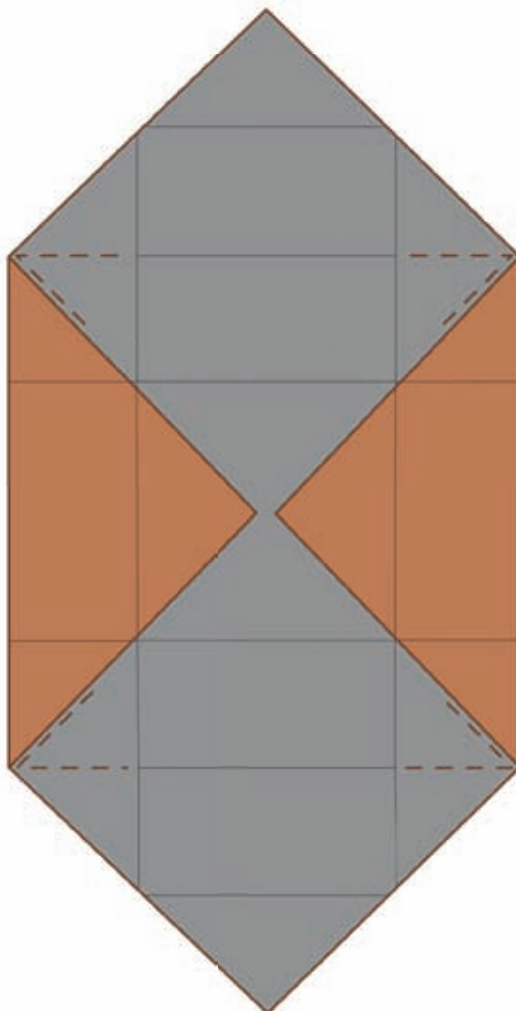

CHRISTMAS GIFT BOX



STEP 5

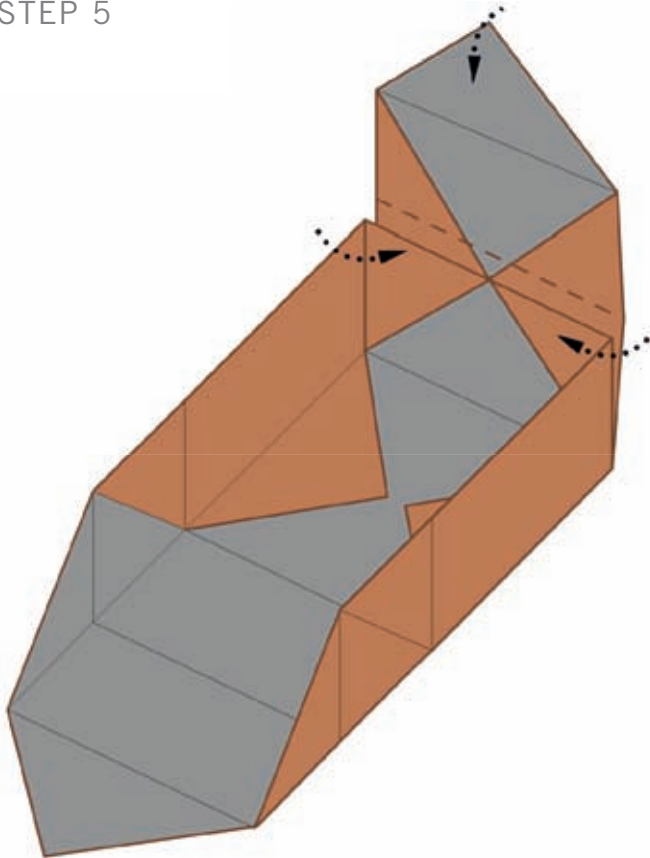

STEP 6

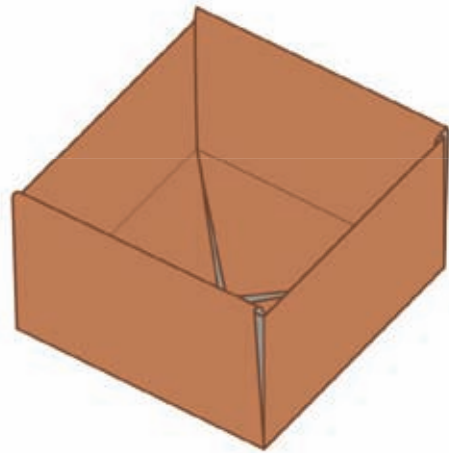

Repeat Step 5

STEP 7

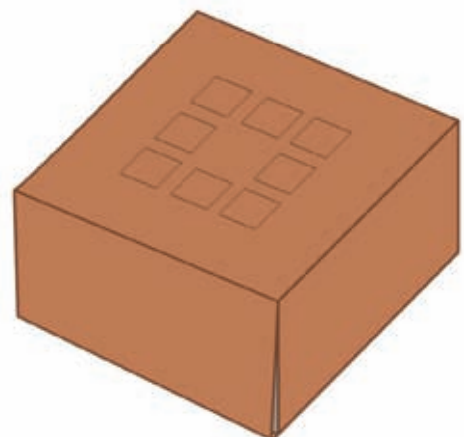

CHRISTMAS GIFT BOX



STEP 8

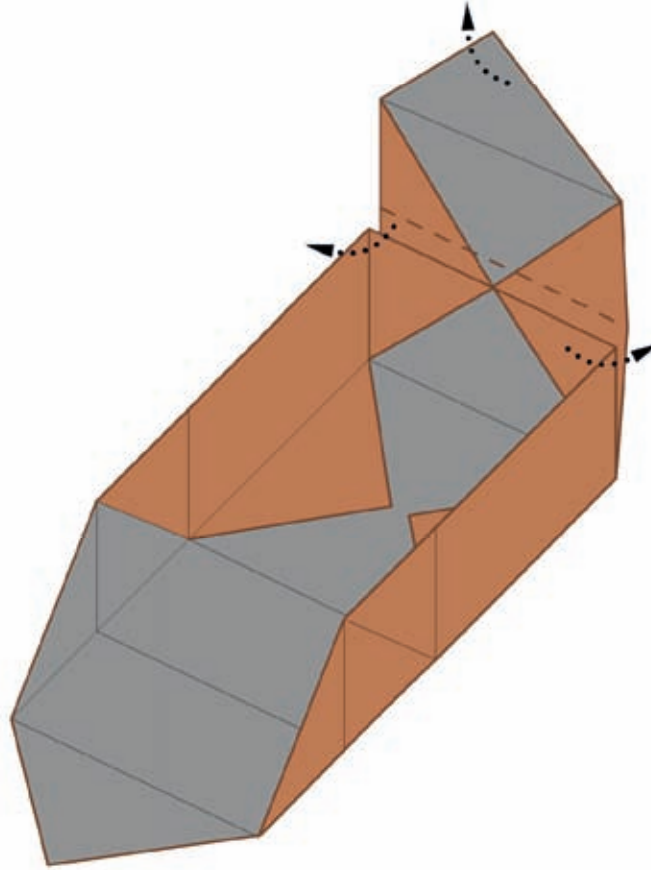

STEP 9

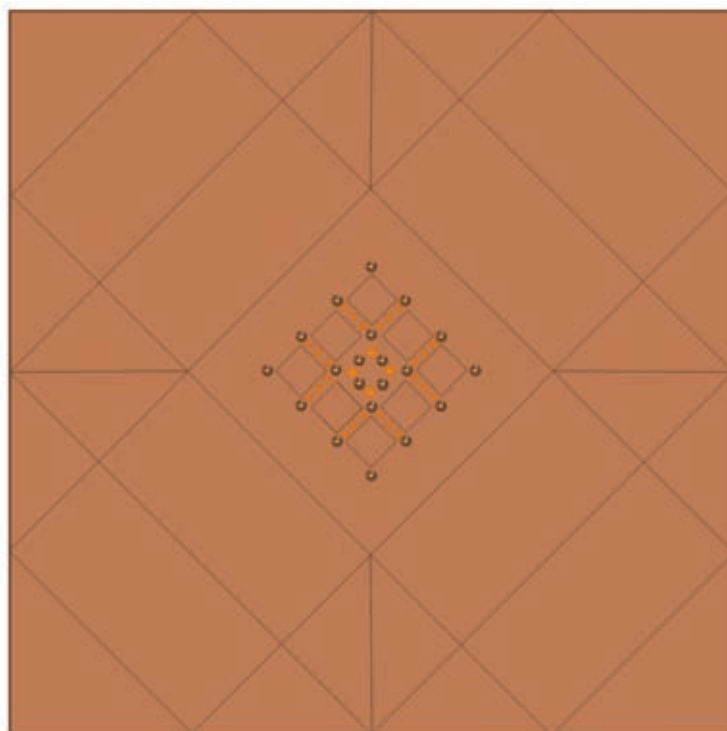

CHRISTMAS GIFT BOX



STEP 10



STEP 11

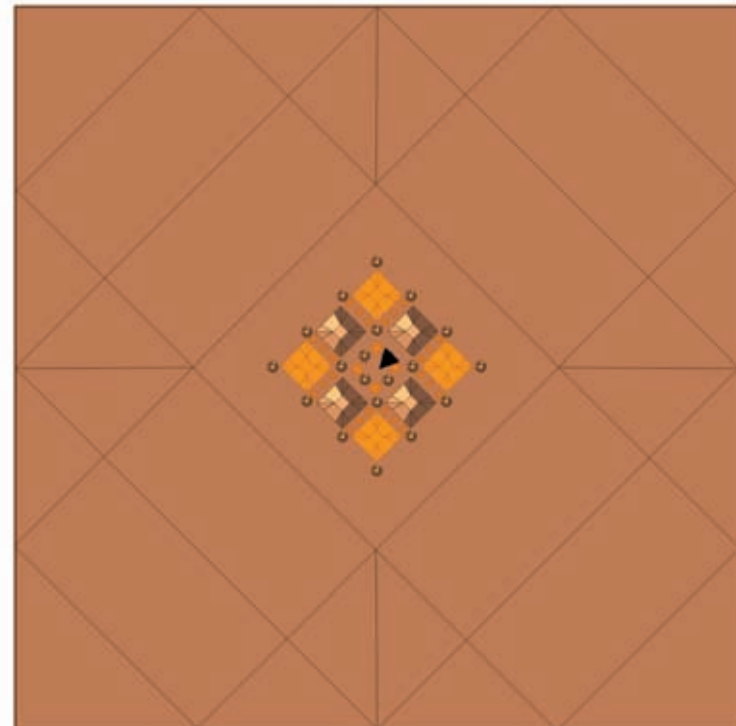

CHRISTMAS GIFT BOX



STEP 12

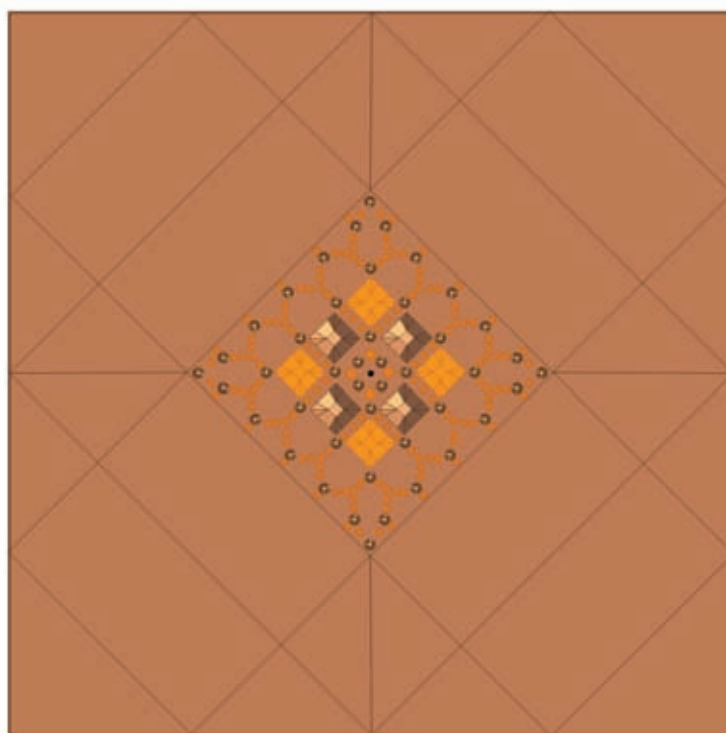

STEP 13

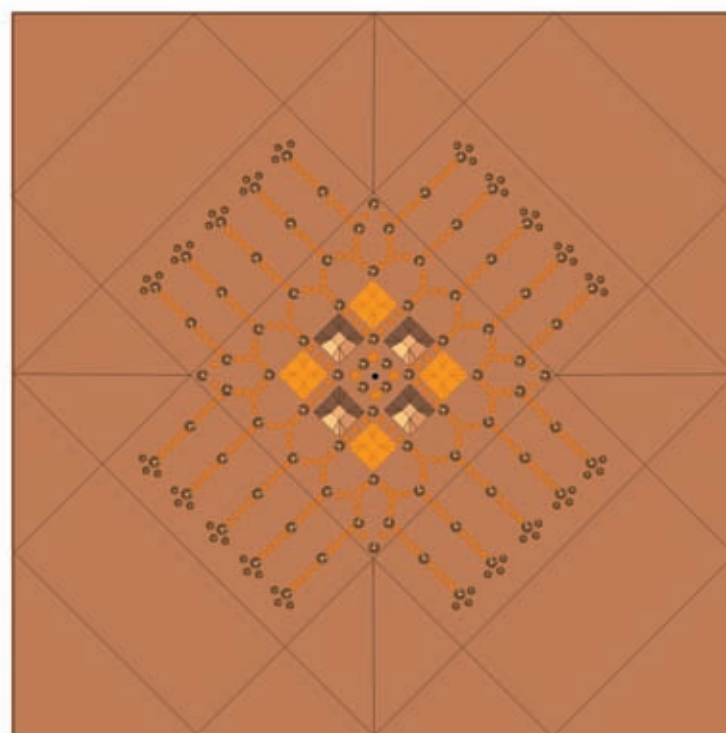

CHRISTMAS GIFT BOX



- Decorating Paper
- Gluing
- Wiring

STEP 14

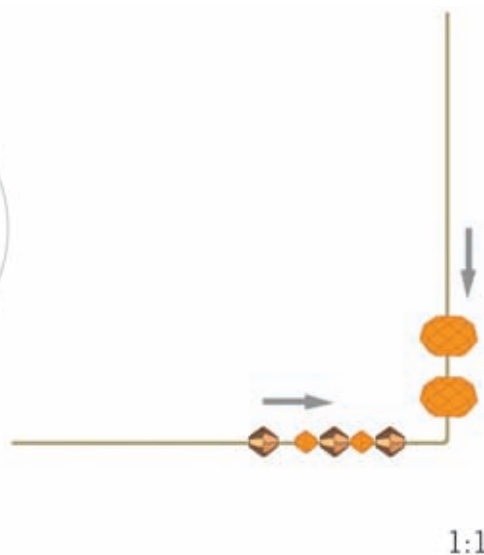
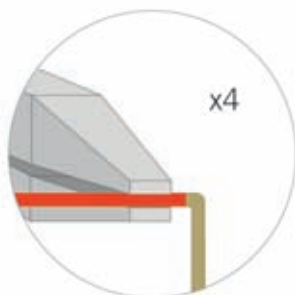
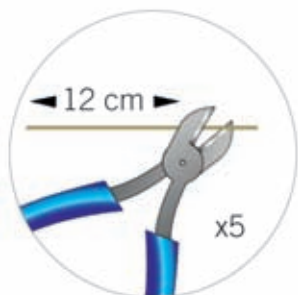

STEP 15



STEP 16

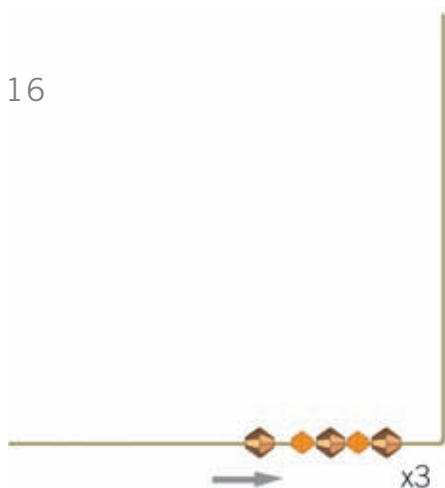

Repeat Step 15 (x3)

CHRISTMAS GIFT BOX



STEP 17

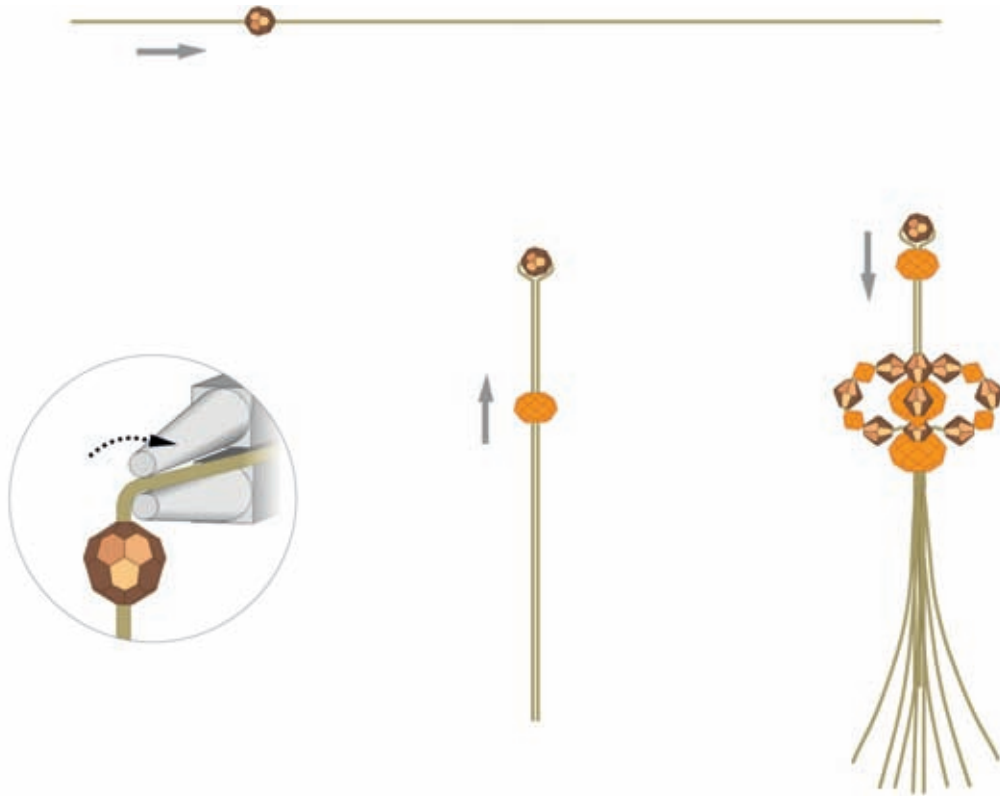

STEP 18

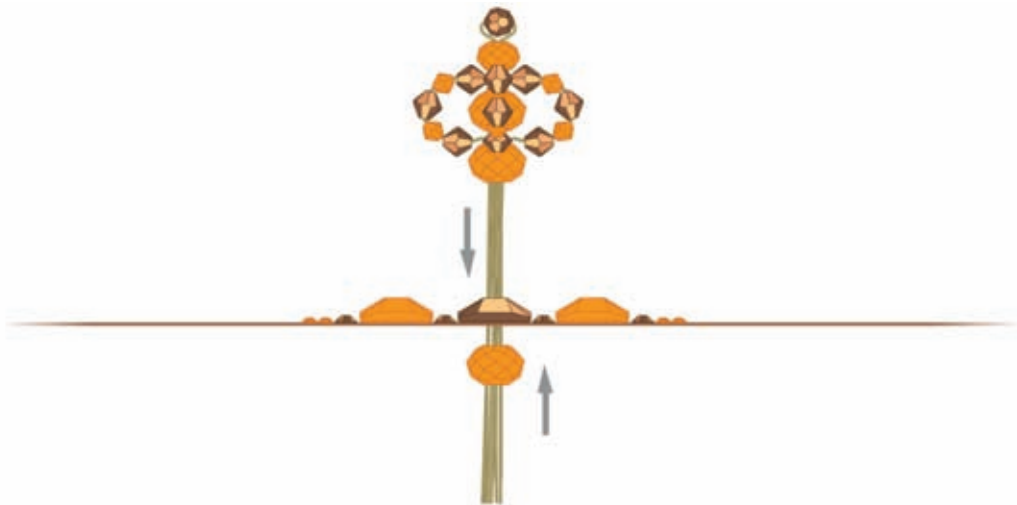

CHRISTMAS GIFT BOX



STEP 19

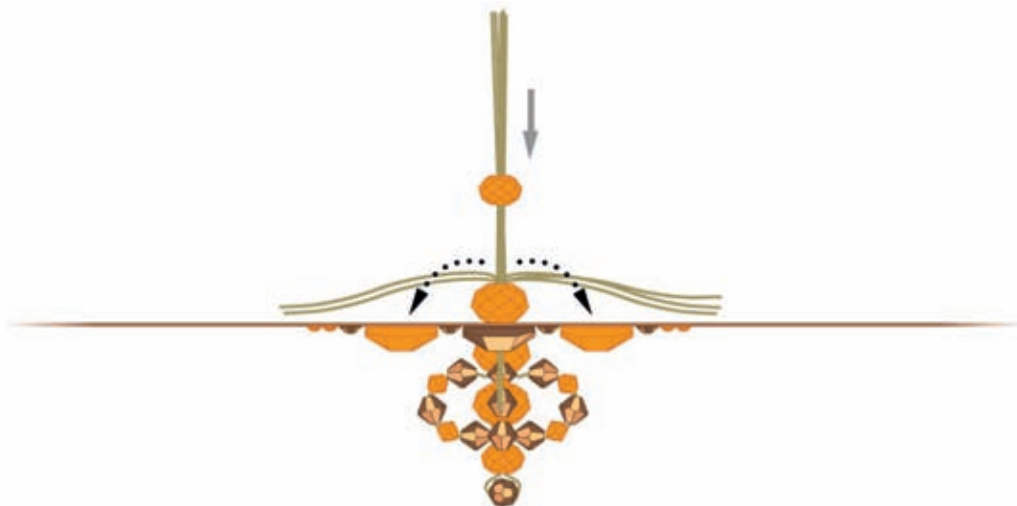

STEP 20



STEP 21

